

Three phase Hybrid Inverter User Manual

(For ASW08KH-T1 , ASW10KH-T1 , ASW12KH-T1)



AiSWEI Technology (Shanghai) Co.,Ltd.

www.solplanet.net

2023 Version: V02

Catalog

1 Notes on this Manual	4
1.1 Scope of Validity	4
1.2 Target Group	4
1.3 Symbols Used	4
2 Safety	4
2.1 Important Safety Instructions	4
2.2 Battery Safety Instructions	7
2.3 Notes on this Manual Explanation of Symbol	7
2.4 CE Directives	8
3 Introduction	8
3.1 Basic features	8
3.2 Simple schematic diagram of system wiring	8
3.3 System Diagram	9
3.4 Work Modes	10
3.4.1 Work modes: Self-consumption mode	10
3.4.2 Work modes: Custom mode	10
3.4.3 Work modes: Reserve power mode	11
3.4.4 Off-grid mode	12
3.5 Dimension	12
3.6 Terminals of Hybrid inverter	12
4 Technical Data	14
5 Installation	16
5.1 Check for Physical Damage	16
5.2 Packing List	16
5.3 Mounting	17
5.3.1 Installation Guide	17
5.3.2 Space Requirement	18
5.3.3 Mounting Steps	18
6 Electrical Connection	19
6.1 Grid Connection	19
6.2 PV connection	20
6.3 BACKUP Connection	21

6.4 Battery Connection 23

6.5 CT Connection..... 24

6.6 DRM Connection 25

6.7 Wi-Fi Connection 25

6.8 RS485 Connection 25

6.9 Inverter Manipulation 26

6.10 Instructions for LED Indicator 27

7 Fault diagnosis and solutions 27

Contact information..... 31

For the latest documents in all supported languages, please visit:

www.solplanet.net



Read this entire document before installation.

PRODUCT SPECIFICATIONS

All specifications and descriptions contained in this document are verified to be accurate at the time of printing. However, because continuous improvement is a goal at SOLPLANET, we reserve the right to make product modifications at any time.

The images provided in this document are for demonstration purposes only. Depending on product version and market region, details may appear slightly different.

ERRORS OR OMISSIONS

To communicate any inaccuracies or omissions in this manual, send an email to service@solplanet.net



ELECTRONIC DEVICE: DO NOT THROW AWAY

Proper Disposal of batteries is required. Refer to your local codes for disposal requirements

MADE IN CHINA

Copyright © AISWEI Technology (Shanghai) Co., Ltd. 2022. All rights reserved.

No part of this document may be reproduced or transmitted in any form or by any means without prior written consent of AISWEI Technology (Shanghai) Co., Ltd.

Trademarks and Permissions

 and other AISWEI trademarks are trademarks of AISWEI Technology (Shanghai) Co., Ltd.

All other trademarks and trade names mentioned in this document are the property of their respective holders.



The information in this document is subject to change without notice. Every effort has been made in the preparation of this document to ensure accuracy of the contents, but all statements, information, and recommendations in this document do not constitute a warranty of any kind, express or implied.

All other trademarks contained in this document are the property of their respective owners and third use herein does not imply sponsorship or endorsement of third products or services. The unauthorized use of any trademark displayed in this document or on the product is strictly prohibited.

1 Notes on this Manual

1.1 Scope of Validity

This manual is an integral part of solplanet three phase hybrid inverter, it describes the assembly, installation, commissioning, maintenance and other information of the product. Please read it carefully before operating.

The descriptions in this manual are applicable to the following models of inverters:





- ASW08KH-T1
- ASW10KH-T1
- ASW12KH-T1

1.2 Target Group

This manual is for qualified electricians. The tasks described in this manual only can be performed by qualified electricians.

1.3 Symbols Used

The following types of safety instructions and general information appear in this document as described below:

 DANGER	Indicates a hazard with a high level of risk which, if not avoided, will result in death or serious injury.
 WARNING	Indicates a hazard with a medium level of risk which, if not avoided, could result in death or serious injury.
 CAUTION	Indicates a hazard with a low level of risk which, if not avoided, could result in minor or moderate injury
 NOTICE	Indicates a potentially hazardous situation which, if not avoided, could result in equipment damage, data loss, performance deterioration, or unanticipated results. Notice is used to address practices not related to personal injury.
 NOTE	Supplements the important information in the main text. NOTE is used to address information not related to personal injury, equipment damage, and environment deterioration.

2 Safety

2.1 Important Safety Instructions

DANGER

- Danger to life due to high voltages in the inverter! All work must be carried out by qualified electrician.
- The appliance is not to be used by children or persons with reduced physical sensory or mental capabilities, or lack of experience and knowledge, unless they have been given supervision or instruction.

CAUTION

- Danger of burn injuries due to hot enclosure parts!
- During operation, the upper lid of the enclosure and the enclosure body may become hot.
- Possible damage to health as a result of the effects of radiation!
- Do not stay closer than 20 cm to inverter for any length of time.

NOTE

- Grounding the PV generator.
- Comply with the local requirements for grounding the PV modules and the PV generator. It is recommended connecting the generator frame and other electrically conductive surfaces in a manner which ensures continuous conduction and ground these in order to have optimal protection of system and persons.

WARNING

- Ensure input DC voltage \leq Max. DC voltage. Overvoltage may cause permanent damage to inverter or other losses, which will not be included in warranty!

WARNING

- Authorized service personnel must disconnect both AC and DC power from inverter before attempting any maintenance or cleaning or working on any circuits connected to inverter.
- Do not operate the inverter when the device is running.

WARNING

- Risk of electric shock!
- Prior to the application, please read this section carefully to ensure correct and safe application. Please keep the user manual properly.
- Accessories only together with the inverter shipment are recommended. Otherwise, may result in a risk of fire, electric shock, or injury to person.
- Make sure that existing wiring is in good condition and that wire is not undersized.
- Do not disassemble any parts of inverter which are not mentioned in installation guide. It contains no user-serviceable parts. See Warranty for instructions on obtaining service. Attempting to service the inverter yourself may result in a risk of electric shock or fire and will void your warranty.
- Keep away from flammable, explosive materials to avoid fire disaster.
- The installation place should be away from humid or corrosive substance.
- Authorized service personnel must use insulated tools when installing or working with this equipment.
- PV modules shall have an IEC 61730 class A rating.
- Never touch either the positive or negative pole of PV connecting device. Strictly prohibit touching both of them at the same time.
- The unit contains capacitors that remain charged to a potentially lethal voltage after the MAINS, battery and PV supply has been disconnected.
- Hazardous voltage will present for up to 5 minutes after disconnection from power supply.
- CAUTION-RISK of electric shock from energy stored in capacitor, never operate on the inverter couplers, the MAINS cables, Battery cables, PV cables or the PV generator when power is applied. After switching off the PV, battery and Mains, always wait for 5 minutes to let the intermediate circuit capacitors discharge before unplugging DC, battery in

plug and MAINS couplers.

- When accessing the internal circuit of inverter, it is very important to wait 5 minutes before operating the power circuit or demounting the electrolyte capacitors inside the device. Do not open the device beforehand since the capacitors require time sufficiently discharge!
- Measure the voltage between terminals UDC+ and UDC- with a multi-meter (impedance at least 1M ohm) to ensure that the device is discharged before beginning work (35VDC) inside the device.

Surge protection devices (SPDs) for PV installation



- Over-voltage protection with surge arresters should be provided when the PV power system is installed.
- Lightning will cause a damage either from a direct strike or from surges due to a nearby strike.
- Induced surges are the most likely cause of lightning damage in majority of installations, especially in rural areas where electricity is usually provided by long overhead lines. Surge may be included on both the PV array conduction and the AC cables leading to the building.
- Specialists in lightning protection should be consulted during the end use application.
- Using appropriate external lightning protection, the effect of a direct lightning strike into a building can be mitigated in a controlled way, and the lightning current can be discharged into the ground.
- Installation of SPDs to protect the inverter against mechanical damage and excessive stress include a surge arrester in case of a building with external lightning protection system (LPS) when separation distance is kept.
- To protect the DC system, surge suppression device (SPD type2) should be fitted at the inverter end of the DC cabling and at the array located between the inverter and the PV generator, if the voltage protection level (VP) of the surge arresters is greater than 1100V, an additional SPD type 3 required for surge protection for electrical devices.
- To protect the AC system, surge suppression devices (SPD type2) should be fitted at the main incoming point of AC supply (at the consumer's cutout), located between the inverter and the meter/distribution system; SPD (test impulse D1) for signal in according to EN 61632-1.
- All DC cables should be installed to provide as short a run as possible, and positive and negative cables of the string or main DC supply should be bundled together.
- Avoiding the creation of loops in the system.
- Spark gap devices are not suitable to be used in DC circuits once conducting, they won't stop conducting until the voltage across their terminals is typically more than 30 volts.
- Anti-Islanding Effect
Islanding effect is a special phenomenon that grid-connected PV system still supply power to the nearby grid when the voltage loss is happened in the power system. It is dangerous for maintenance personnel and the public.

PE Connection and Leakage Current



High leakage current!

Earth connection essential before connecting supply.

- Incorrect grounding can cause physical injury, death or equipment malfunction and increase electromagnetic.
- Make sure that grounding conductor is adequately sized as required by safety regulations.

- Do not connect the ground terminals of the unit in series in case of a multiple installation. This product can cause current with a d.c component, where a residual current operated protective (RCD) or monitoring (RCM) device is used for protection in case of direct or indirect contact, only an RCD or RCM of type B is allowed on the supply side of this product.

2.2 Battery Safety Instructions

ASW H-T1 Series hybrid inverter should be worked with high voltage battery, for the specific parameters such as battery type, nominal voltage and nominal capacity etc.











As accumulator batteries may contain potential electric shock and short-circuit current danger, to avoid accidents that might be thus resulted, the following warnings should be observed during battery replacement:

- 1) Do not wear watches, rings or similar metallic items.
- 2) Use insulated tools.
- 3) Put on rubber shoes and gloves.
- 4) Do not place metallic tools and similar metallic parts on the batteries.
- 5) Switch offload connected to the batteries before dismantling battery connection terminals.
- 6) Only personal with proper expertise can carry out the maintenance of accumulator batteries.

2.3 Notes on this Manual Explanation of Symbol

This section gives an explanation of all the symbols shown on the inverter and the label.

Symbols on the Type Label

Symbol	Explanation
	CE Mark The inverter complies with the requirements of the applicable CE guidelines.
	TUV certified.
	RCM Mark
	Certification.
	Beware of hot surface. The inverter can become hot during operation. Avoid contact during operation.
	Danger of high voltages. Danger to life due to high voltages in the inverter!
	Risk of electric shock!
	Observe enclosed documentation
	The inverter cannot be disposed together with the household waste. Disposal information can be found in the enclosed documentation.
	Do not operate this inverter until it is isolated from battery, mains and on-site PV generation suppliers.



Danger to life due to high voltage.
 There is residual voltage existing in the inverter after powering off .
 which needs 5 min to discharge.
 Wait 5 min before you open the upper lid or the DC lid.

2.4 CE Directives

This chapter follows the requirements of the European low voltage directives, which contains the safety instructions and conditions of acceptability for the end user system, which you must follow when installing, operating and servicing the unit. The Grid connected inverter meets the requirement stipulated in Low Voltage Directive (LVD) 2014/35/EU and Electromagnetic Compatibility (EMC) Directive 2014/30/EU. The grid connected inverter leave the factory completely connecting device and ready for connection to the mains and PV supply, the unit shall be installed in accordance with national wiring regulations. Compliance with safety regulations depends upon installing and configuring system correctly, including using the specified wires.

The system must be installed only by professional assemblers who are familiar with requirements for safety and EMC. The assembler is responsible for ensuring that the end system complies with all the relevant laws in the country where it is to be used.

3 Introduction

3.1 Basic features

ASW H-T1 Series hybrid inverter is a high-quality inverter which can convert solar energy to AC energy and store energy into battery.

The inverter can be used to optimize self-consumption, store in the battery for future use or feed into public grid. Work mode depends on PV energy and user's preference. It can provide power for emergency use during the grid lost by using the energy from battery and inverter generated from PV.

3.2 Simple schematic diagram of system wiring

ASW H-T1 Series hybrid inverter is designed with two BACKUP interface for customer to choose based on the local rules. ASW H-T1 Series hybrid inverter applies to the wiring rules that requires the Live line and Neutral line of BACKUP must be disconnected with the Live line and Neutral line of grid (applies to most countries).

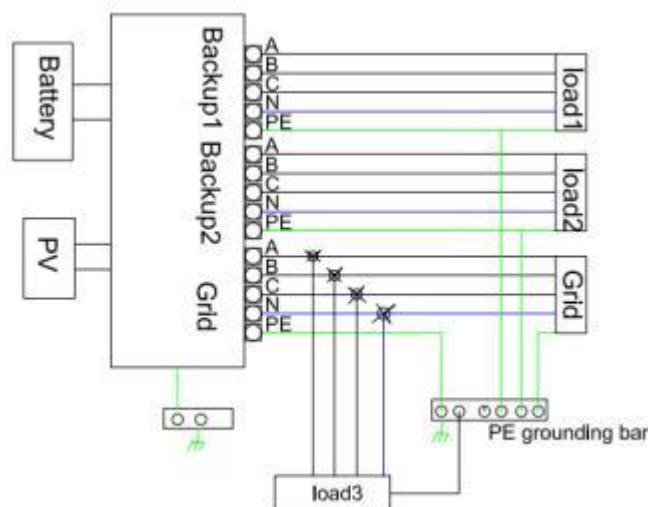

NOTE

- The wiring diagram is for reference only, and the complete electrical connection shall meet the requirements of local regulations.
- Please control the home loads, and make sure it's within the "BACKUP output rating" under BACKUP mode, otherwise the inverter will shut down with an "overload fault" warning.
- Please confirm with the mains grid operator whether there are any special regulations for grid connection.

3.3 System Diagram

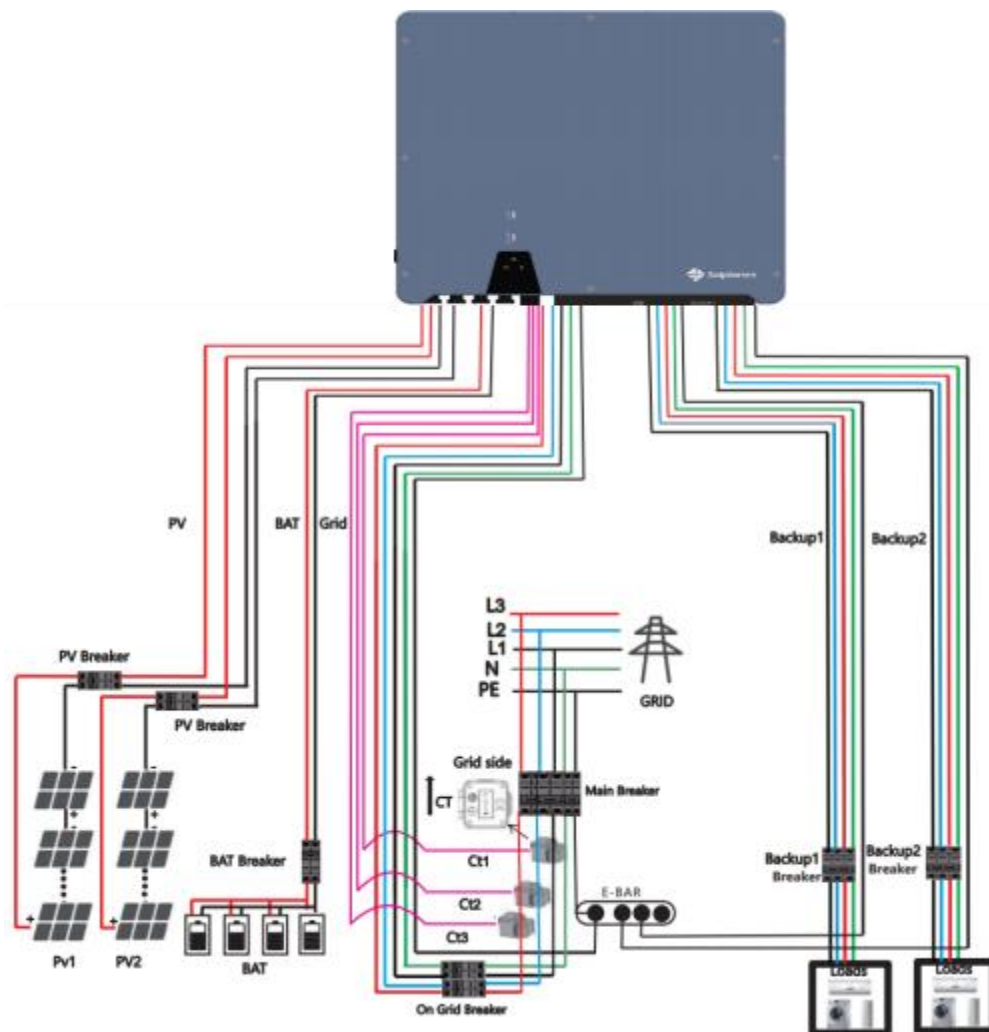

NOTE

- The arrow on the CT points from inverter to the public grid, as shown.
- As shown in the figure, the CT1 line is yellow, the CT2 line is green, and the CT3 line is red.
- Do not misconnect the phase sequence.
- Backup load is connected to Backup1 or Backup2 port.
- Because the length of CT line is limited, the inverter needs to be installed near the parallel dot, otherwise the

anti-countercurrent function cannot be used.

- Please control the home loads, and make sure it's within the "BACKUP output rating" under BACKUP mode, otherwise the inverter will shut down with an "overload fault" warning.
- Please confirm with the main grid operator whether there are any special regulations for grid connection.
- BACKUP1 for very important load, BACKUP2 for important or normal load.

When power is outage or when there is no grid power .

- 1) If the battery does not report low voltage or undervoltage alarm, the inverter will supply power to both BACKUP1 and BACKUP2.
- 2) If battery voltage is too low for full load or undervoltage alarm, the inverter only can supplies power to BACKUP1.

3.4 Work Modes

Inverter provides multiple work modes based on different requirements.

3.4.1 Work modes: Self-consumption mode

3.4.1.1 When PV, Grid, Battery is available

- 1) Solar energy provides power to the loads as first priority, if solar energy is sufficient to power all connected loads, solar energy excess power will provide to charge battery, and then redundant power will feed to grid .



- 2) Solar energy provides power to the loads as first priority , if solar energy and battery are not sufficient to power all connected loads, utility energy (Main Grid) will supply power to the loads with solar energy at the same time .



3.4.1.2 When PV, Grid is available (without battery):

- 3) Solar energy provides power to the loads as first priority, if solar energy is sufficient, the excess power will feed to grid.



- 4) Solar energy provides power to the loads as first priority, if solar energy is not sufficient to power all connected loads, Grid energy will supply power to the loads at the same time.



3.4.2 Work modes: Custom mode

3.4.2.1 When PV, Grid, Battery is available:

- 5) On charge time, solar energy will charge battery as first priority . The excess energy will supply power to the loads. If solar energy is sufficient to supply loads and charge battery, and If there's still some extra energy, then the excess power will feed the power to grid



- 6) On charge time, solar energy will charge battery as first priority. Then the excess solar energy will supply power to loads. If solar energy is not sufficient to charge battery and supply loads, grid will supply all the connected loads with solar energy together.



- 7) On discharge time, solar energy provides power to the loads as first priority, if solar energy is sufficient to supply loads, and if there's still some extra energy from solar energy, then the excess power and battery will deliver the power to the grid at the same time.



- 8) In the period of no charge or discharge, the solar power supply loads at first priority, excess energy to the grid.



3.4.2.2 When Grid, Battery is available (PV is disconnected)

- 9) On charge time, grid will charge battery and supply power to the connected loads at the same time.



- 10) On discharge time, if load power is less than battery power, battery will supply power to loads as first priority, the excess power will be feed to grid.



- 11) On discharge time, if load power is more than battery power, battery and grid will supply power to the loads at the same time.



3.4.3 Work modes: Reserve power mode

3.4.3.1 When PV, Grid, Battery is available:

- 12) Solar energy will charge battery as first priority, if solar energy is excess, the excess power will supply load. If there's still some extra energy, then the excess power will feed the power to grid.



- 13) Solar energy will charge battery as first priority, if solar energy is excess, the excess power will supply load. If solar energy is not sufficient to charge battery and supply loads, grid will supply power to loads.



3.4.3.2 When Grid, Battery is available (PV is disconnected)

14) Grid will supply power to load and charge battery at the same time.



NOTE

If set anti-Reverse function allowable, once on the work mode of Self- use, Peak shift, battery priority, the system will not feed power to grid.

3.4.4 Off-grid mode

3.4.4.1 When PV, Battery is available Grid is disconnected):

15) A. Solar energy provides power to the loads as first priority, if solar energy is sufficient to power all connected loads, solar energy will provide to charge battery .



16) B. Solar energy provides power to the loads as first priority, if solar energy is not sufficient to power all connected loads, battery energy and solar energy will supply power to the loads at the same time.



3.5 Dimension

Unit: mm

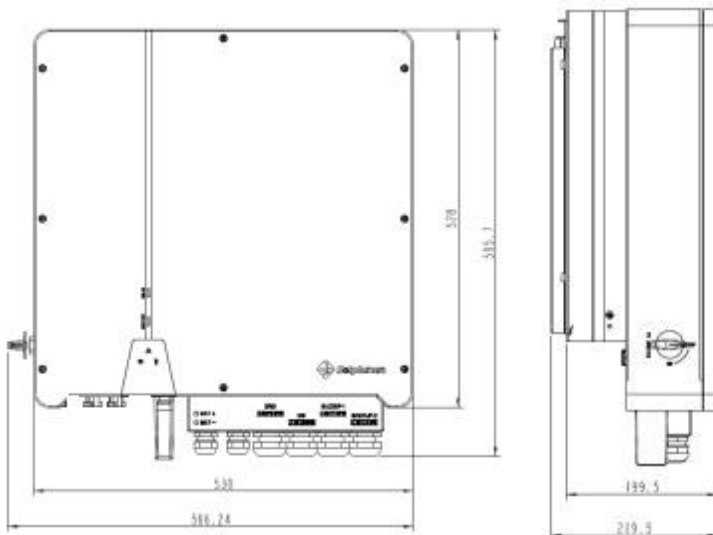

3.6 Terminals of Hybrid inverter

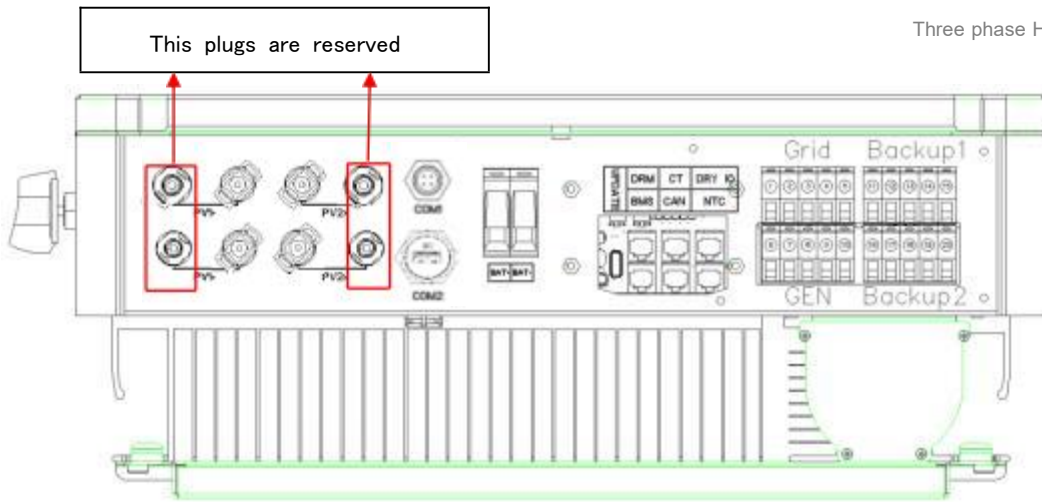

Function	label	Description
PV string 1 Input port	PV1+	PV string 1 positive input
	PV1-	PV string 1 negative input
PV string 2 Input port	PV2+	PV string 2 positive input
	PV2-	PV string 2 negative input
Communication interface	COM1	RS485 port
	COM2	WI-FI stick interface
BAT Port	BAT+	Battery positive input
	BAT-	Battery negative input
Signal line interface	UPDATE	Upgrading software Ports
	DRM	Function temporarily retained
	CT	Connect to CT (current transformer)
	DRY IO	Dry contact
	BMS	BMS communication to Battery
	CAN	CAN communication
	NTC	NTC detection
Grid	①	Grid line A phase
	②	Grid line B phase
	③	Grid line C phase
	④	Grid line Neutral
	⑤	Grid line PE
GEN (Diesel generator function is unreleased currently)	⑥	GEN line A phase
	⑦	GEN line B phase
	⑧	GEN line C phase
	⑨	GEN line Neutral
	⑩	GEN line PE
Backup1	⑪	Backup1 line A phase
	⑫	Backup1 line B phase
	⑬	Backup1 line C phase
	⑭	Backup1 line Neutral ,
	⑮	Backup1 line PE
Backup2	⑯	Backup2 line A phase
	⑰	Backup2 line B phase
	⑱	Backup2 line C phase
	⑲	Backup2 line Neutral
	⑳	Backup2 line PE



- Qualified electrician will be required for the installation.

4 Technical Data

Model		ASW08kH-T1	ASW10kH-T1	ASW12kH-T1
PV Input	Max. PV array power	12 kWp STC	15 kWp STC	18 kWp STC
	Max. input voltage	1000 V		
	MPP voltage range	180 V ~ 850 V		
	Min. input voltage / start voltage	125V/180V		
	No. of independent MPPT trackers / strings per MPPT input	2 / (1/1)		
	Max. input current per MPP tracker	13 A		
	Max. short-circuit current per MPP tracker	25A		
Battery	Battery type	Lithium-ion		
	Battery voltage range	125 V ~ 600 V		
	Max. charging current / Max. discharging current	50 A / 50A		
	Rated. charging current / Rated. discharging current	40A/40A		
AC output	Nominal AC voltage	3W+N+PE, 220 / 380 V; 230 / 400 V; 240 / 415 V		
	AC voltage range	360V~440V		
	Rated AC grid frequency	50 Hz / 60 Hz		
	AC grid frequency range	50 Hz±5Hz / 60 Hz±5Hz		
	Rated active power	8 kW	10 kW	12 kW
	Rated apparent power	8 kVA	10 kVA	12 kVA
	Max. apparent power	8.8 kVA	11 kVA	13.2 kVA
	Rated grid output Current (@400V)	11.6 A	14.5 A	17.4 A
	Max. grid output current	12.7A	15.9A	19.1A
	Harmonics THDi (@ Nominal power)	< 3%		
AC input	Rated grid voltage	3W+N+PE, 220 / 380 V; 230 / 400 V; 240 / 415 V		
	Rated grid frequency	50Hz / 60Hz		
	Rated apparent power	16 kW	20 kW	24 kW
	Max. input apparent power from grid	17.6 kVA	22 kVA	26.4 kVA
	Rated input current from grid	23.1 A	28.9A	34.7 A
	Max. input current from grid	25.5 A	31.8A	38.2 A
BACKUP output	Nominal output voltage	3W+N+PE, 220 / 380 V; 230 / 400 V; 240 / 415 V		
	Nominal output frequency	50 Hz / 60 Hz		
	Rated apparent power	8 kVA	10 kVA	12 kVA
	Max. output apparent power	8 kVA	10 kVA	12 kVA

Model		ASW08kH-T1	ASW10kH-T1	ASW12kH-T1
	Peak output apparent power	8.8kVA	11kVA	13.2kVA
	Rated Current (@400V)	11.6 A	14.5 A	17.4 A
	Max. output current	12.7A	15.9A	19.1A
	Max. switch time	≤20 ms		
	Output THDi (@ Linear load)	<2%		
Efficiency	MPPT efficiency	≥99.5%		
	Max efficiency	97.90%	98.20%	98.20%
	Euro efficiency	97.20%	97.50%	97.50%
	Max. battery to load efficiency	96.50%	96.50%	96.60%
Safety protection	DC-side disconnection device	●		
	PV string- / Battery input reverse polarity protection	● / ●		
	All-pole sensitive residual current monitoring unit	●		
	Anti-islanding protection	●		
	AC output over current protection	●		
	AC output short circuit current protection	●		
	AC over voltage protection	●		
	Protection class (as per IEC 62109-1)	I		
	overvoltage category (as per IEC 62109-1)	AC: III; DC: II		
General data	Power factor at rated power / adjustable displacement	≥0.99 / 0.8 leading to 0.8 lagging		
	Dimensions (W / D / H)	570 / 200 / 600 mm		
	Device weight	35 kg	36kg	
	Installation	Wall-mounted		
	Operating temperature range	-25 °C~+60 °C		
	Noise emissions (typical)	< 35 dB(A)		
	Standby consumption	< 3 W		
	Cooling concept	Natural convection		
	Ingress protection rating (as per IEC 60529)	IP65		
	Climatic category (according to IEC 60721-3-4)	4K4H		
	Max. permissible value for relative humidity	0~95%		
	(non-condensing)			
	Max. operating altitude	4000m (>2000m power derating)		
	Country of Manufacture	THE PEOPLE'S REPUBLIC OF CHINA		

Model		ASW08kH-T1	ASW10kH-T1	ASW12kH-T1
Features	Inverter topology (Solar/ battery)	Transformer less / Transformer less		
	User interface	LED & App		
	Communication with BMS	RS485 / CAN		
	Communication with meter	RS485		
	Communication with portal	WIFI stick		
	Integrated power control / Zero export control	● / ●		
Standard Compliance	Grid	EN 50549- 1, RfG 3		
	Safety	EN 62109-1, EN 62109-2		
	EMC	IEC 61000-6- 1/-2/-3/-4, IEC 61000-3- 11, IEC61000-3- 12		
	The certification will continue to increase			

5 Installation

5.1 Check for Physical Damage

Make sure the inverter is intact during transportation. If there is any visible damage, such as cracks, please contact your dealer immediately.

5.2 Packing List

Open the package and take out the product, please check the accessories first. The packing list shown as below.

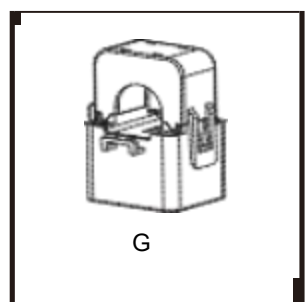
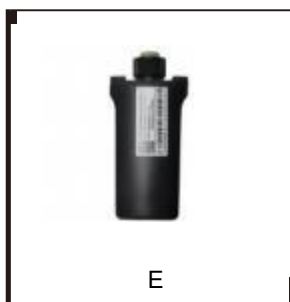
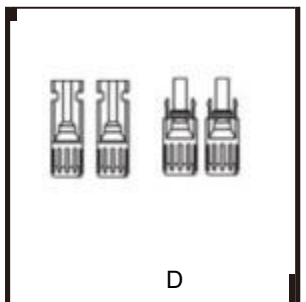
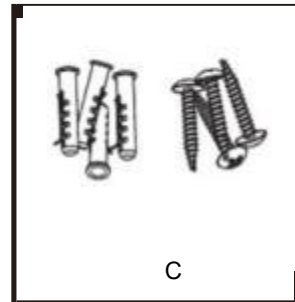
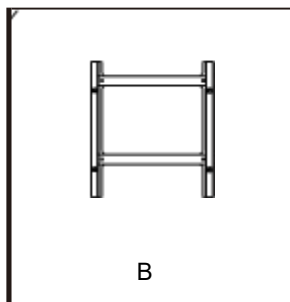
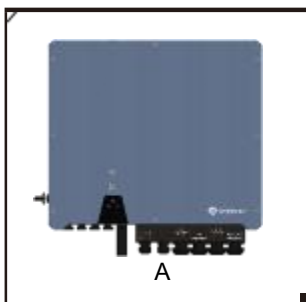

Object	Description
A	Inverter
B	Bracket
C	Expansion screws and pan-head screws
D	PV connectors (2*positive, 2*negative)
E	WiFi stick (optional)
F	User manual
G	Current transformer

5.3 Mounting

5.3.1 Installation Guide

ASW H-T1 Series hybrid inverter is designed for outdoor installation (IP 65). Make sure the installation site meets the following conditions:

- 1) Not in direct sunlight.
- 2) Not in areas where highly flammable materials are stored.
- 3) Not in potential explosive areas.
- 4) Not in the cool air directly.
- 5) Not near the television antenna or antenna cable.
- 6) Not higher than altitude of about 2000m above sea level.
- 7) Not in environment of precipitation or humidity (> 95%).
- 8) Under good ventilation condition.
- 9) The ambient temperature in the range of -20°C to +60°C .
- 10) The slope of the wall should be within $\pm 5^\circ$.
- 11) The wall hanging the inverter should meet conditions below:
 - solid brick/concrete, or strength equivalent mounting surface.
 - Inverter must be supported or strengthened if the wall's strength isn't enough (such as wooden wall, the wall covered by thick layer of decoration)

Please AVOID direct sunlight, rain exposure, snow laying up during installation and operation.



5.3.2 Space Requirement

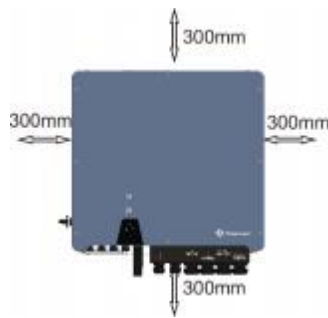

Position	minimum spacing
Left	300mm
Right	300mm
Top	300mm
Bottom	300mm

5.3.3 Mounting Steps

5.3.3.1 Tools required for installation.



Installation tools: crimping pliers for binding post and RJ 45, screwdriver, manual wrench etc.

- Step 1: Screw the wall bracket on the wall
 - ✓ Place the bracket on the wall and mark down the position of the 4 holes.
 - ✓ Drill holes with driller, make sure the holes are deep enough (at least 60mm) to support the inverter.
 - ✓ Install the expansion tubes in the holes and tighten them. Then install the wall bracket with the expansion screws.

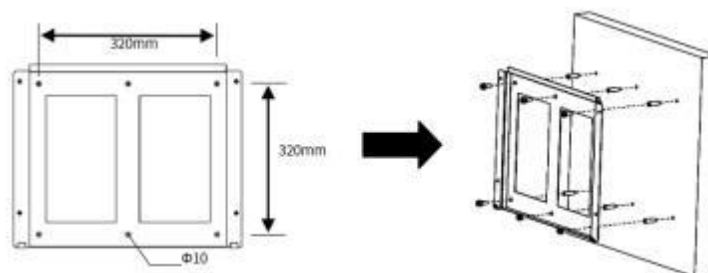

- Step 2: Place the inverter on the wall mounted bracket by holding the handle on the side.

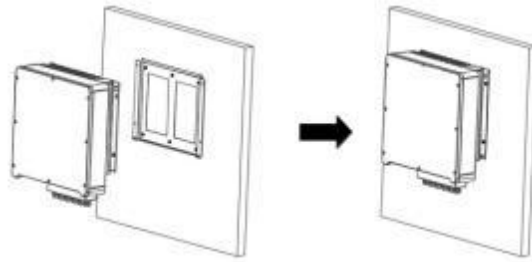

- Step 3: Tighten the fixing screws on both sides of the inverter.
- Step 4: If necessary, customer can install an anti-theft lock on the left-bottom of the inverter.

6 Electrical Connection

6.1 Grid Connection

ASW H-T1 Series hybrid inverter is designed for three phase grid Voltage is 380/400V, frequency is 50/60Hz.

Table 4 Cable and Micro-breaker recommended

Inverter	ASW08kH-T1	ASW10kH-T1	ASW12kH-T1
Cable	4~6 mm ²		6~10 mm ²
Micro-breaker	20A	32A	32A

Note:

- Copper cable is recommended.
- If aluminum core cable is used, the cable with larger cross-sectional area shall be selected.
- Micro-breaker should be installed between inverter and grid, any load should not be connected with inverter directly.

Connection Steps:

- 1) Step1. Check the grid voltage.
 - Check the grid voltage and compare with the permissive voltage range (Please refer to technical data).
 - Disconnect the circuit board from all the phases and secure against re-connection.
- 2) Step2. Remove the waterproof lid from the grid port on the inverter.

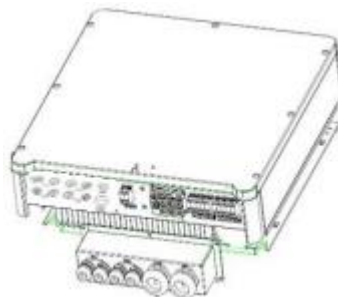

- 3) Step3. Make AC wires.
 - Choose the appropriate wire (Cable size: refer to Table 4).
 - Reserve about 60mm of conductor material sectional area.
 - Remove 10mm of insulation from the end of wire.

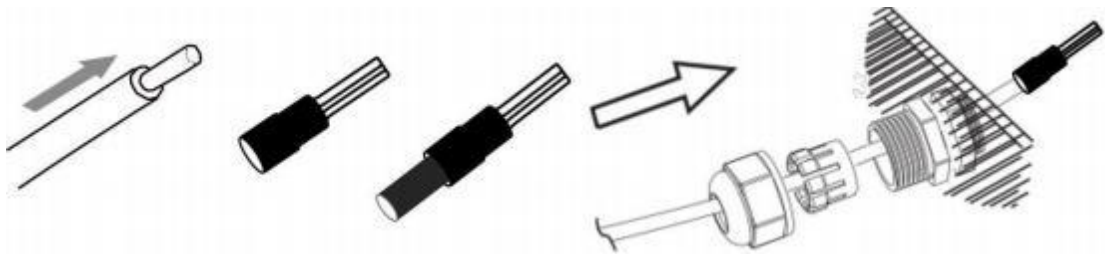

4) Step4. Connect the AC connector to the GRID port of the inverter with a slotted screwdriver

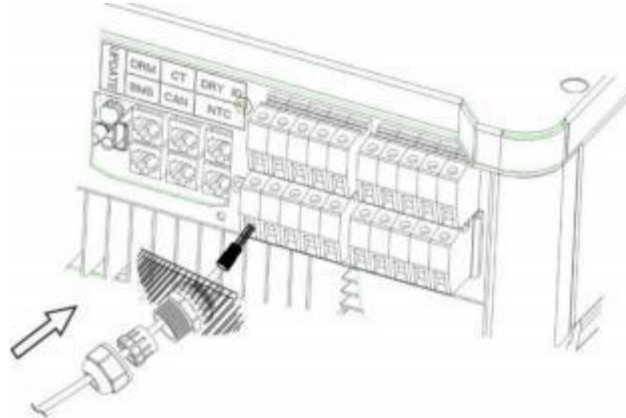

6.2 PV connection

ASW H-T1 Series hybrid inverter can be connected in series with 2-strings PV modules for 8KW,10KW,12KW.

Select PV modules with excellent function and reliable quality. Open-circuit voltage of module arrays connected in series should be <Max. DC input voltage; operating voltage should be conformed to MPPT voltage range.

Max.DC Voltage Limitation

Type	ASW08KH-T1	ASW10KH-T1	ASW12KH-T1
Max. DC Voltage(V)	1000		
MPPT Voltage Range(V)	180 ~ 850		

WARNING

- PV module voltage is very high, which already achieve dangerous voltage range, please comply with electric safety rules when connecting.
- Please do not make PV positive or negative ground.

NOTE

- The following requirements of PV modules need to be applied for each input area.
- Please do not make PV positive or negative ground!
- In order to save cable and reduce the DC loss, we suggest installing the inverter near PV modules.

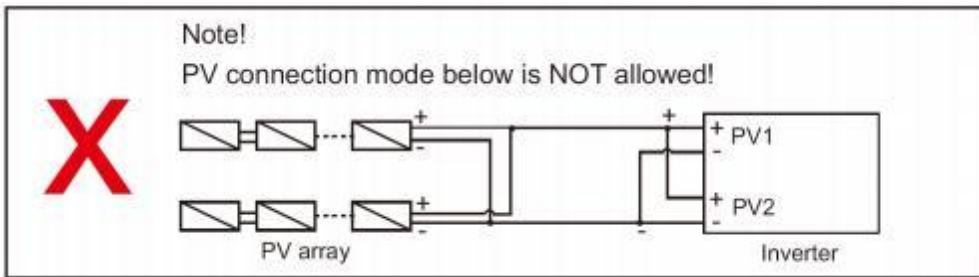

Connection Steps:

1) Step1. Checking PV module.

- Use multimeter to measure module array voltage.
- Check the PV+ and PV- from the PV string combiner box correctly.
- Please make sure the impedance between the positive pole and negative pole of PV to earth should be $M\Omega$ level.

2) Step2. Separating the DC connector.

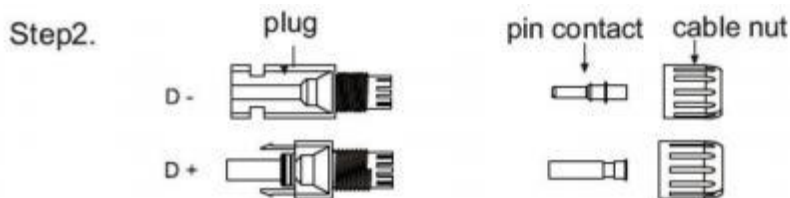

3) Step3. Wiring.

- Choose the 12 AWG wire to connect with the cold-pressed terminal.
- Remove 10mm of insulation from the end of wire.
- Insert the insulation into pin contact and use crimping plier to clamp it.

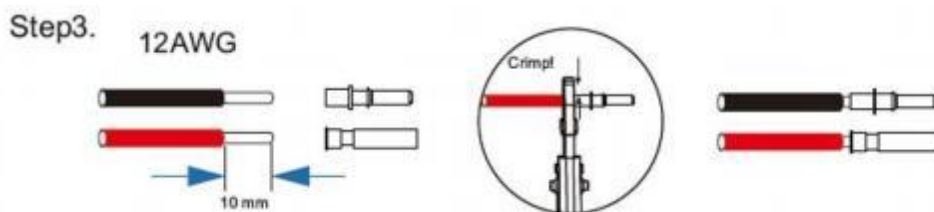

4) Step4. Insert pin contact through the cable nut to assemble into back of the male or female plug. When you feel or heard a "click" sound the pin contact assembly is seated correctly.

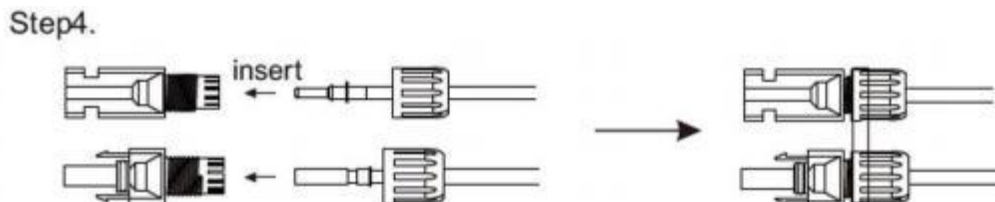

5) Step5. Plug the PV connector into the corresponding PV connector on inverter

6.3 BACKUP Connection

ASW H-T1 Series hybrid inverter has On and Off grid function, the inverter will deliver output power through AC port when the grid is on, and it will deliver output power through BACKUP port when the grid is off. BACKUP1 for very important load, BACKUP2 for important or normal load.

When there is a power outage or when there is no power grid

- 1) If the battery does not report low voltage or undervoltage alarm, the inverter will supply power to both BACKUP1 and BACKUP2
- 2) If battery voltage is too low for full load or undervoltage alarm, the inverter only can supplies power to BACKUP1

Connection Steps:

1) Step1.Make BACKUP wires

- Choose the appropriate wire (cable size: refer to picture below).
- Reserve about 60mm of conductor material sectional area.
- Remove 10mm of insulation from the end of wire.

2) Step2. Connect the AC connector to the BACKUP port of the inverter with a slotted screwdriver

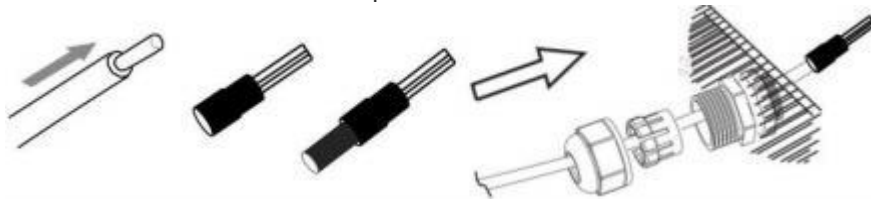
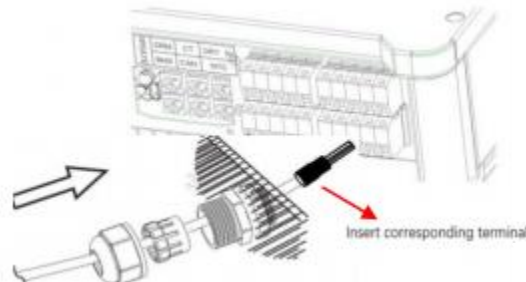

Table 5 Cable and Micro-breaker recommended

Inverter	ASW08kH-T1	ASW10kH-T1	ASW12kH-T1
Cable	4~6 mm ²		6~10 mm ²
Micro-breaker	20A	32A	32A











Requirements for BACKUP load



- Make sure the BACKUP load power rating is within BACKUP output rating, otherwise the inverter will shut down with an "overload" warning.
- When an "overload" is appeared, adjust the load power to make sure it is within the BACKUP output power range, then turn the inverter back on.

Below table shows some common feasible loads for you reference.

Type	Power		Common equipment	Example		
	Start	Rated		Equipment	Start	Rated
Resistive load	R 1	R 1	  Incandescent lamp TV	 100W Incandescent lamp	100VA (W)	100VA (W)
Capacitive load	R 2	R 1.5	 Fluorescent lamp	 40W Fluorescent lamp	80VA (W)	60VA (W)
Inductive load	R 3~5	R 2	  Fan Fridge	 150W Fridge	450-750VA (W)	300VA (W)

6.4 Battery Connection

Charging & discharging system of ASW H-T1 Series hybrid inverter is designed for high-voltage lithium battery.

Before choosing battery, please note the voltage of battery and the battery communication should be compatible with ASW H-T1 Series hybrid inverter.

Battery breaker

Before connecting to battery, please install a nonpolarized DC breaker to make sure inverter can be securely disconnected during maintenance

Model	ASW08KH-T1	ASW10KH-T1	ASW12KH-T1
Voltage	Nominal voltage of DC breaker should be larger than maximum voltage of battery.		
Current[A]	60A		

Battery connection diagram

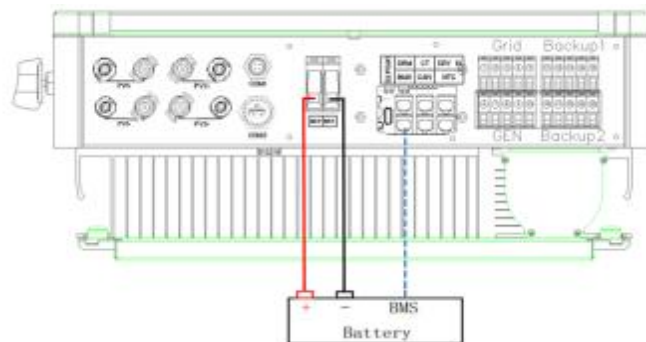

BMS PIN Definition Communication interface between inverter and battery is RS485 or CAN with a RJ45 connector

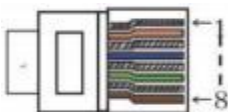

	PIN	1	2	3	4	5	6	7	8
CAN	Deinition	X	X	X	BMS_CANH	BMS_CANL	X	X	X

Battery power cable Connection Steps:

- 1) Step1. Choose the 10mm² wire and strip the cable to 15mm.



- 2) Step2. Remove waterproof cover plate.

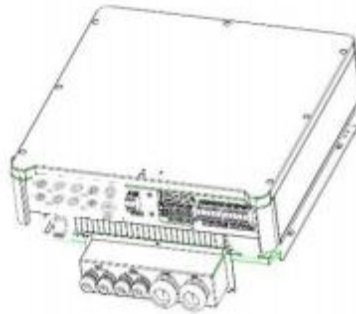

- 3) Step3. Disassemble the waterproof connector and pass the cable through the waterproof connector.

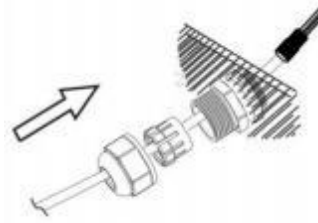

- 4) Step4. Connect the cable to the terminal of the inverter.

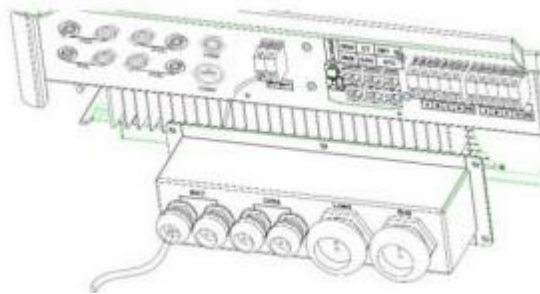

- 5) Step5. Assemble waterproof connectors and waterproof covers plate.

6.5 CT Connection

CT is used for monitoring the power usage for entire house.

NOTE

- The arrow on the CT points to the power grid, as shown.
- The yellow and green red lines of CT correspond to the phase lines of grid ABC respectively .
- As shown in the figure, the yellow line is Grid line A phase , the green line is Grid line B phase , the red line is Grid line C phase , the blue line is Grid line Neutral , the black line is Grid line PE.

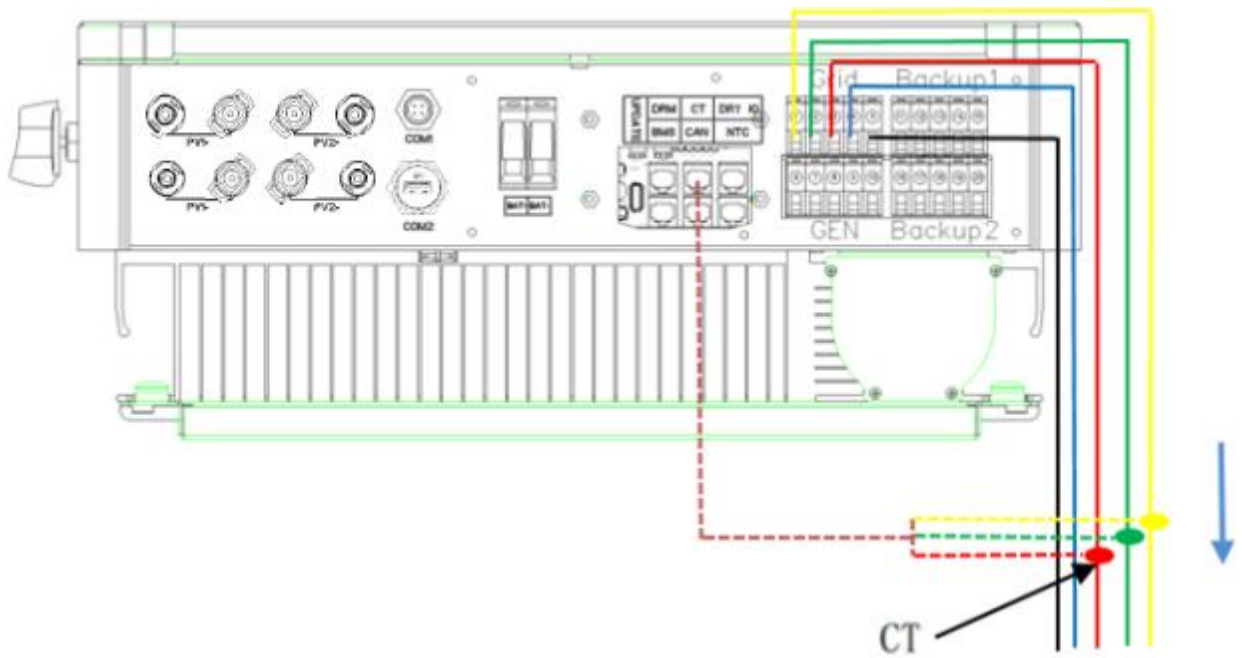

6.6 DRM Connection

This feature is currently reserved

6.7 Wi-Fi Connection

The connection refers to “Wi-Fi stick User Manual” for detail information.

WIFI Connection Steps:

Step1. Plug Wi-Fi into “WIFI” port at the bottom of the inverter.

Step2. Build the connection between the inverter and router.

Step3. Create a user account online. (Please check the WIFI user manual for more details). Please connect to the port above

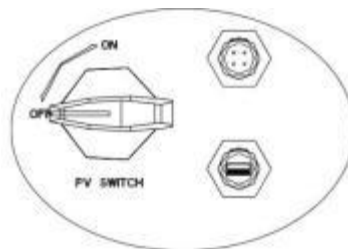

Please refer to the Smart Plug user manual for detailed connection Steps.

Please connect to the port below

6.8 RS485 Connection

Connect the RS485 port according to the signal pin shown in the following figure . COM1 is RS485 port.

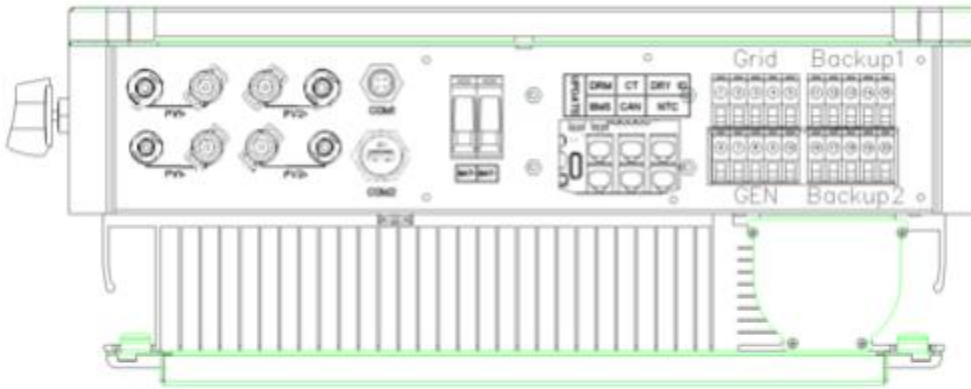

COM

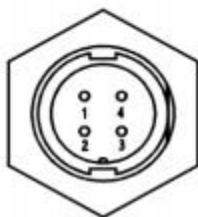

1	2	3	4
+5V	RS485_A	RS485_B	GND

6.9 Inverter Manipulation

Start inverter after checking all below Steps:

- Ensure the inverter fixed well on the wall.
- Make sure all the DC wirings and AC wirings are completed.
- Make sure the meter/CT is connected well.
- Make sure the battery is connected well.
- Make sure the external BACKUP contactor is connected well.
- (If needed) Turn on the AC switch and BACKUP switch
- Turn on the PV/DC switch and battery switch

Check the inverter:

























- 1) Step1. Check the status of indicators and App.

NOTE

- If the left indicator is not blue, please check below the three points:
 - All the connections are correct.
 - All the external breakers are switched on.
 - The DC switch on the inverter is in the “ON” position.
- 2) Step2. If it is the first time to start up, please follow it.

6.10 Instructions for LED Indicator

INDICATOR STATUS EXPLANATION

INDICATOR	STATUS	EXPLANATION
SOLAR 	 BLUE ON	PV ACTIVE
	 BLUE BLINK	SELF-CHECK/ SOFT UPGRADE
	 BLUE OFF	PV NOT ACTIVE
BATTERY 	 BLUE ON	BATTERY ACTIVE
	 BLUE BLINK	SOC LOM/ SOFT UPGRADE
	 BLUE OFF	BATTERY NOT ACTIVE
ERR 	 YELLOW ON	COMMUNICATION FAULT
	 YELLOW BLINK	WARNING
	 RED ON	FUALT
	 OFF	NORMAL WORK
EPS 	 BLUE ON	EPS OUTPUT WITH LOAD
	 BLUE BLINK	EPS OUTPUT WITHOUT LOAD
	 RED ON	EPS OUTPUT FAULT
	 RED BLINK	EPS OUTPUT OVERLOAD
	 OFF	EPS WITHOUT OUTPUT
GRID 	 BLUE ON	GRID IS ACTIVE AND CONNECTED
	 BLUE BLINK	GRID IS ACTIVE AND FORCED OFF-GRID
	 RED ON	GRID FAULT
	 OFF	INVERTER SHUTDOWN

7 Fault diagnosis and solutions

The inverter is easy to maintain. When you encounter the following problems, please refer to the Solutions below, and contact the local distributor if the problem remains unsolved. The following table lists some of the basic problems that may occur during the actual operation as well as their corresponding basic solutions.

Fault diagnosis table

Content	Codes	Solutions
DischgOverCur	00 29	nothing needs to do, wait one minute for the inverter to restart. Check whether the load is in compliance with the specification. Cut off all the power and shut down all the machines; disconnect the load and plug in to restart machines, then check whether the load is short circuited if the fault has been eliminated. Contact customer service if error warning continues.
Overload	01	Check whether the load is in compliance with the maximum power of the machine. Cut off all the power and shut down all the machines; disconnect the load and plug in to restart machines, then check whether the load is short circuited if the fault has been eliminated. Contact customer service if error warning continues.
Bat Disconnect	02	Check if the battery not connected. Check if battery wiring port is open circuited. Contact customer service if error warning continues.
Bat Under Vol	03 04 26	Check if the battery is in line with the presetting, If so, power off and restart. Check if the grid is powered down. If the power is off, wait for the grid to powered up, the grid will automatically charge the battery. Contact customer service if error warning continues.
Bat Over Vol	05 27	Check if the battery is in line with the presetting, If so, power off and restart. Contact customer service if error warning continues.
gird low vol	06	Check if the grid is abnormal. Restart the inverter and wait until it functions normally. Contact customer service if error warning continues.
grid over vol	07	Check if the grid is abnormal. Restart the inverter and wait until it functions normally. Contact customer service if error warning continues.
grid low freq	08	Check if the grid is abnormal. Restart the inverter and wait until it functions normally. Contact customer service if error warning continues.
grid overFreq	09	Check if the grid is abnormal. Restart the inverter and wait until it functions normally. Contact customer service if error warning continues.
GFCI over	10	Check PV string for direct or indirect grounding phenomenon. Check peripherals of machine for current leakage. Contact the local inverter customer service if fault remains unremoved.

Content	Codes	Solutions
SolarUnconect	11	PV is not connected. PV switch is not closed. Check PV availability.
Grid CtReverse	12	Check whether the CT is connected in the correct direction. Contact customer service if error warning continues.
bus under vol	13	Check the input mode setting is correct. Restart the inverter and wait until it functions normally. Contact customer service if error warning continues.
bus over vol	14	Check the input mode setting is correct. Restart the inverter and wait until it functions normally. Contact customer service if error warning continues.
inv over cur	15	Restart the inverter and wait until it functions normally. Contact customer service if error warning continues.
chg over cur	16	Check if battery wiring is short circuited. Check if charging current is in compliance with presetting. Contact customer service if error warning continues.
bus vol osc	17	Cut off all the power and shut down all the machines and restart.
inv under vol	18	Contact customer service if error warning continues.
inv over vol	19	
InvFreqAbnor	20	
env temp high	21	Cut off all the power of the machine and wait one hour, then turn on the power of the machine. Contact customer service if error warning continues.
bat over temp	23	Disconnect the battery and reconnect it after an hour. Contact customer service if error warning continues.
Bat UnderTemp	24	Check the ambient temperature near the battery to see if it meets the specifications. Contact customer service if error warning continues.
BatCellUnball	25	Break the grid, use the battery to supply power to the load, reconnect the grid side switch after half an hour, Wait another half an hour and check the fault status again. Contact customer service if error warning continues.
chg over cur	28	Check if battery wiring port is short circuited . Check if charging current is in compliance with presetting. Contact customer service if error warning continues.

Content	Codes	Solutions
bus soft fail	32	Restart the inverter and wait until it functions normally. Contact customer service if error warning continues.
inv soft fail	33	
bus short	34	
inv short	35	
fan fault	36	
BusRelayFault	38	
GridRlyFault	39	
BACKUP rly fault	40	
GFCI fault	41	
Load CT fault	42	
OffgridRlyFal	44	
system fault	45	
PViso low	37	
PV short	43	Restart the inverter and wait until it functions normally. Disconnect the PV input, restart the inverter and wait until it functions normally. Contact customer service if error warning continues.
bat reverse	46	Check if the inverter battery positive and negative connection is correct. Contact customer service if error warning continues.

Contact information

CHINA

AISWEI Technology (Shanghai) Co., Ltd.

Address: Room 905B, 757 Mengzi Road, Huangpu District, Shanghai, 200120, China

Sales: +86 512 6937 2978

sales.china@aiswei-tech.com

Service: +86 400 801 9996

service.china@aiswei-tech.com

SOLPLANET INTERNATIONAL

info@solplanet.net

sales@solplanet.net

service@solplanet.net

SOLPLANET POLAND

Sales: +48 600 721 791

sales.pl@solplanet.net

Service: +48 134 926 109

service.pl@solplanet.net

SOLPLANET HUNGARY

Sales: +36 70 787 0070

sales.hu@solplanet.net

Service: +36 465 00 384

service.hu@solplanet.net

SOLPLANET AUSTRALIA

Sales: +61 390 988 674

sales.au@solplanet.net

Service: +61 390 988 674

service.au@solplanet.net

SOLPLANET BRAZIL

Support: +55 51 99765 3389

Sales: +55 51 99800 8500

sales.br@solplanet.net

service.br@solplanet.net

SOLPLANET GERMANY

Sales: +49 151 59184325

sales.eu@solplanet.net

Service: +31 20 800 4844

service.eu@solplanet.eu

SOLPLANET KOREA

Sales: +82 31 422 8110

sales@solplanet.com

Service: +82 31 422 8110

service@solplanet.com

SOLPLANET SPAIN

Sales: +34 676 633 900

sales.es@solplanet.net

Service: +31 20 800 4844

service.eu@solplanet.eu

SOLPLANET THE NETHERLANDS

Sales: +31 202 402 557

sales.nl@solplanet.net

Service: +31 208 004 844

service.eu@solplanet.net

SOLPLANET TURKEY

Sales: +90 554 631 1089

sales.tr@solplanet.net

Service: +90 850 346 0024

service.tr@solplanet.net