

Single phase string inverters

ASW S-S SERIES

User Manual

ASW1000S-S / 1500S-S / 2000S-S / 3000S-S



Solplanet inverterTable of Contents

1	Notes on this Manual	4
1.1	General Notes	4
1.2	Area of validity	4
1.3	Target group	4
1.4	Symbols used in this manual	5
2	Safety	7
2.1	Intended use	7
2.2	Important safety information	8
2.3	Symbols on the label	11
3	Unpacking	13
3.1	Scope of delivery	13
3.2	Checking for transport damage	14
4	Mounting	14
4.1	Ambient conditions	14
4.2	Selecting the mounting location	16
4.3	Mounting the inverter with the wall bracket	17
5	Electrical Connection	20
5.1	Safety	20
5.2	System layout of units without integrated DC switch	21
5.3	Overview of the connection area	22
5.4	AC connection	23
5.4.1	Conditions for the AC connection	23
5.4.2	Grid connection	25

5.4.3	Second protective grounding connection	27
5.4.4	Residual current protection	28
5.4.5	Overvoltage category	29
5.4.6	Grounding conductor monitoring	29
5.4.7	Rating of miniature circuit-breaker	30
5.5	DC Connection	31
5.5.1	Requirements for the DC Connection	31
5.5.2	Assembling the DC connectors	32
5.5.3	Disassembling the DC connectors	35
5.5.4	Connecting the PV array	36
6	Communication	37
6.1	System monitoring via RS485/ Ethernet	37
6.2	System monitoring via WLAN	42
6.3	Inverter demand response modes (DRED)	43
6.4	Active power control with Smart meter & AiCom/AiManager	44
6.5	Communication with third-party devices	45
6.6	Earth Fault Alarm	45
7	Commissioning	46
7.1	Electrical checks	46
7.2	Mechanical checks	47
7.3	Safety code check	47
7.4	Start-Up	48
8	Display	49
8.1	Overview of the panel	49
8.1.1	LEDs	50
9	Disconnecting the Inverter from Voltage Sources	51

10 Technical Data	53
10.1 DC input data	53
10.2 AC output data	54
10.3 General data	56
10.4 Safety regulations	57
10.5 Efficiency.....	59
10.6 Power reduction	63
10.6.1 Power reduction with increased ambient temperature (ASW1000S-S)	63
10.6.2 Power reduction with increased ambient temperature (ASW1500S-S)	63
10.6.3 Power reduction with increased ambient temperature (ASW2000S-S)	64
10.6.4 Power reduction with increased ambient temperature (ASW3000S-S)	64
10.7 Tools and torque	66
11 Troubleshooting	67
12 Maintenance	69
12.1 Cleaning the contacts of the DC switch.....	69
12.2 Cleaning the heat sink.....	69
13 Recycling and disposal	70
14 EU Declaration of Conformity.....	70
15 Warranty	71
16 Contact.....	71

1 Notes on this Manual

1.1 General Notes

Solplanet inverter is a transformerless solar inverter with single MPP tracker. It converts the direct current (DC) from a photovoltaic (PV) array to grid-compliant alternating current (AC) and feeds it into the utility grid.

1.2 Area of validity

This manual describes mounting, installation, commissioning and maintenance of the following Solplanet inverters:

ASW1000S-S
ASW1500S-S
ASW2000S-S
ASW3000S-S

Observe all documentation that accompanies the inverter. Keep them in a convenient place and available at all times.

1.3 Target group

This manual is for qualified electricians only, who must perform the tasks exactly as described.

All persons installing inverters must be trained and experienced in general safety which must be observed when working on electrical equipments. Installation personnel should also be familiar with local requirements, rules and regulations.

Qualified persons must have the following skills:

- Knowledge of how an inverter works and is operated
- Training in how to deal with the dangers and risks associated with installing, repairing and using electrical devices and installations

- Training in the installation and commissioning of electrical devices.
- Knowledge of all applicable laws, standards and directives
- Knowledge of and compliance with this document and all safety information

1.4 Symbols used in this manual

Safety instructions will be highlighted with the following symbols:



DANGER indicates a hazardous situation which, if not be avoided, will result in death or serious injury.



WARNING indicates a hazardous situation which, if not be avoided, can result in death or serious injury.



CAUTION indicates a hazardous situation which, if not be avoided, can result in minor or moderate injury.

NOTICE

NOTICE indicates a situation which, if not be avoided, can result in property damage.



INFORMATION that is important for a specific topic or goal, but is not safety-relevant.

2 Safety

2.1 Intended use

1. The inverter converts the direct current from PV array into grid-compliant alternating current.
2. The inverter is suitable for indoor and outdoor use.
3. The inverter must only be operated with PV arrays (PV modules and cabling) of protection class II, in accordance with IEC 61730, application class A. Do not connect any sources of energy other than PV modules to the inverter.
4. PV modules with a high capacitance to ground must only be used if their coupling capacitance is less than 1.0 μ F.
5. When the PV modules are exposed to sunlight, a DC voltage is supplied to this inverter.
6. When designing the PV system, ensure that the values comply with the permitted operating range of all components at all times.
7. The inverter must only be used in countries for which it is approved or released by AISWEI and the grid operator.
8. Use this inverter only in accordance with the information provided in this documentation and with the locally applicable standards and directives. Any other application may cause personal injury or property damage.
9. The type label must remain permanently attached to the product.

2.2 Important safety information

DANGER

Danger to life due to electric shock when live components or cables are touched

- All work on the inverter must only be carried out by qualified personnel who have read and fully understood all safety information contained in this manual.
- Do not open the product.
- Children must be supervised to ensure that they do not play with this device.



DANGER

Danger to life due to high voltages of the PV array

When exposed to sunlight, the PV array generates dangerous DC voltage which is present in the DC conductors and the live components of the inverter. Touching the DC conductors or the live components can lead to lethal electric shocks. If you disconnect the DC connectors from the inverter under load, an electric arc may occur leading to electric shock and burns.

- Do not touch non-insulated cable ends.
- Do not touch the DC conductors.
- Do not touch any live components of the inverter.
- Have the inverter mounted, installed and commissioned only by qualified persons with the appropriate skills.
- If an error occurs, have it rectified by qualified persons only.
- Prior to performing any work on the inverter, disconnect it from all voltage sources as described in this document (see Section 9 "Disconnecting the Inverter from Voltage Sources").



WARNING

Risk of injury due to electric shock

Touching an ungrounded PV module or array frame can cause a lethal electric shock.

- connect and ground the PV modules, array frame and electrically conductive surfaces so that there is continuous conduction.

 **CAUTION**

Risk of burns due to hot enclosure parts

Some parts of the enclosure can get hot during operation.

- During operation, do not touch any parts other than the enclosure lid of the inverter.







NOTICE

Damage to the inverter due to electrostatic discharge

Internal components of the inverter can be irreparably damaged by electrostatic discharge.

- Ground yourself before touching any component.

2.3 Symbols on the label

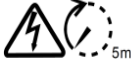
Symbol	Explanation
	Beware of a danger zone This symbol indicates that the product must be additionally grounded if additional grounding or equipotential bonding is required at the installation site.
	Beware of high voltage and operating current The inverter operates at high voltage and current. Work on the inverter must only be carried out by skilled and authorized electricians.
	Beware of hot surfaces The inverter can get hot during operation. Avoid contact during operation.
	WEEE designation Do not dispose of the product together with the household waste but in accordance with the disposal regulations for electronic waste applicable at the installation site.
	CE marking The product complies with the requirements of the applicable EU directives.
	Certification mark The product has been tested by TUV and got the quality certification mark.
	RCM Mark The product complies with the requirements of the applicable Australian standards.
	Capacitors discharge Before opening the covers, the inverter must be disconnected from the grid and PV array. Wait at least 5 minutes to allow the energy storage capacitors to fully discharge.









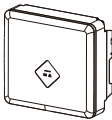
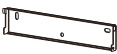

Observe the documentation

Observe all documentation supplied with the product

3 Unpacking

3.1 Scope of delivery

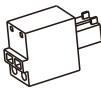
Object	Description	Quantity
A	Inverter	1 piece
B	Wall mounting bracket	1 piece
C	Mounting accessory kit: Wall anchors and hexagon bolts (3x) M4x10 mm screw (3x)	1 set
D	DC connector	1 pair
E	AC Plug connector	1 piece
F	WLAN (optional)	1 piece (optional)
G	Documentation	1 set
H	Smart meter terminal	1 piece
I	(optional)	1 set(optional)

			
A	B	C	D
			
E	F	G	H
			
I			

Carefully check all of the components in the carton. If anything is missing, contact your dealer.

3.2 Checking for transport damage

Thoroughly inspect the packaging upon delivery. If you detect any damage to the packaging which indicates the inverter may have been damaged, inform the responsible shipping company immediately. We will be glad to assist you if required.

4 Mounting

4.1 Ambient conditions

1. Be sure the inverter is installed out of the reach of children.
2. Mount the inverter in areas where it cannot be touched inadvertently.
3. Ensure good access to the inverter for installation and possible service.
4. Make sure that heat can dissipate, observe the following minimum clearance to walls, other inverters, or objects:

Direction	Min. clearance (mm)
above	300
below	500
sides	200

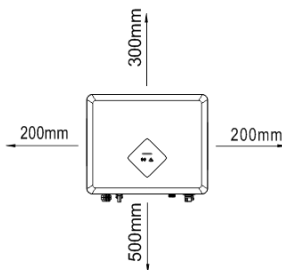

5. The ambient temperature should be below 40°C to ensure optimal operation.
6. Recommend to mount the inverter under the shaded site of the building or mount an awning above the inverter.

7. Avoid exposing the inverter to direct sunlight, rain and snow to ensure optimal operation and extend service life.

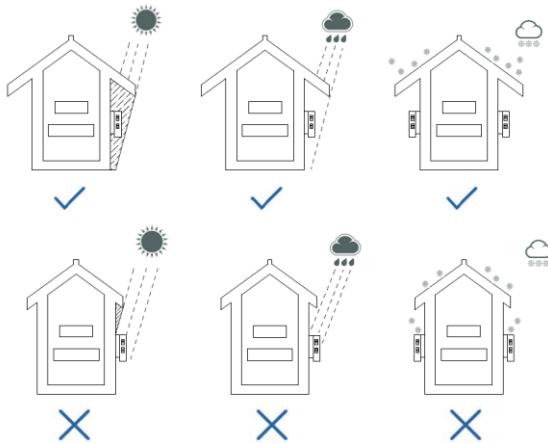

8. The mounting method, location and surface must be suitable for the inverter's weight and dimensions.
9. If mounted in a residential area, we recommend mounting the inverter on a solid surface. Plasterboard and similar materials are not recommended due to audible vibrations when in use.
10. Do not put any objects on the inverter.
11. Do not cover the inverter.

4.2 Selecting the mounting location

WARNING

Danger to life due to fire or explosion

- Do not mount the inverter on flammable construction materials.
- Do not mount the inverter in areas where flammable materials are stored.
- Do not mount the inverter in areas where there is a risk of explosion.

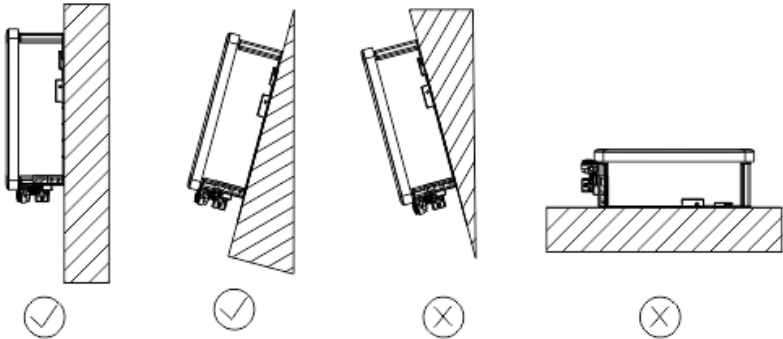

1. Mount the inverter vertically or tilted backward by a maximum of 15°.
2. Never mount the inverter tilted forward or sideways.
3. Never mount the inverter horizontally.
4. Mount the inverter at eye level to make it easy to operate and to read the display.
5. The electrical connection area must point downwards.

4.3 Mounting the inverter with the wall bracket

⚠ CAUTION

Risk of injury due to the weight of the inverter

- When mounting, take into account that the inverter weighs approx. :
ASW1000-S – ASW3000S-S: 6.5kg.

Mounting procedures:

1. Use the wall bracket as a drilling template and mark the positions of the drill holes. Drill 3 holes with a 10 mm drill. The holes must be about 70 mm deep. Keep the drill vertical to the wall, and hold the drill steady to avoid tilted holes.

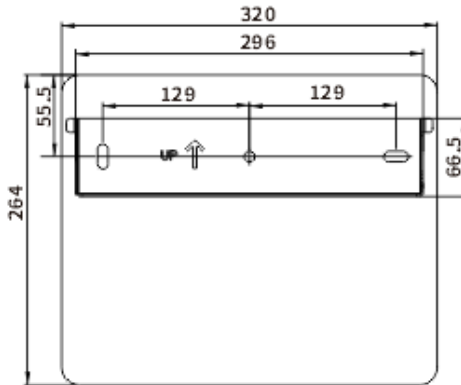

⚠ CAUTION

Risk of injury due to the inverter falls down

- Before inserting the wall anchors, measure the depth and distance of the holes.
- If the measured values do not meet the hole requirements, redrill the holes.

2. After drilling holes in the wall, place three screw anchors into the holes, then attach the wall mounting bracket to the wall using the self-tapping screws delivered with the inverter.

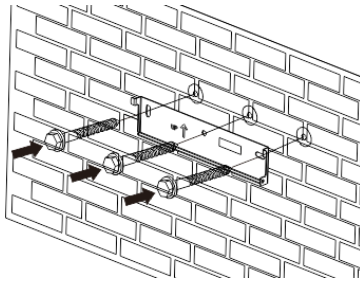

3. Holding the inverter and attach it tilted slightly downwards to the wall bracket.

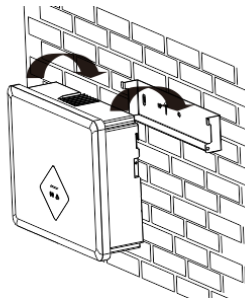

4. Check both sides of the inverter to ensure that it is securely in place.

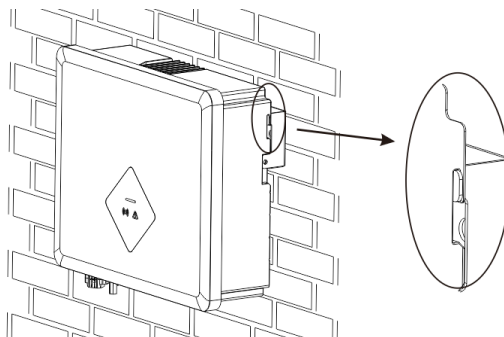

5. Push the inverter as far as possible and attach it to the right side of the wall bracket using the M4 screws.

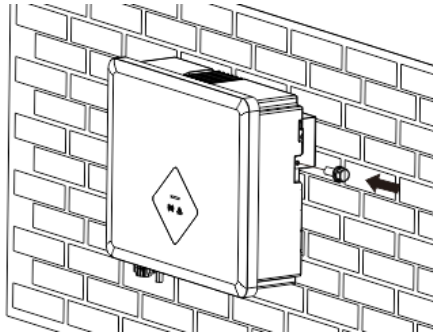

If a second protective conductor is required in installation site, ground the inverter and secure it so that it cannot drop from the housing (see section 5.4.3 “Second protective grounding connection”).

Dismante the inverter in reverse order.

5 Electrical Connection

5.1 Safety

DANGER

Danger to life due to high voltages of the PV array

When exposed to sunlight, the PV array generates dangerous DC voltage which is present in the DC conductors and the live components of the inverter. Touching the DC conductors or the live components can lead to lethal electric shocks. If you disconnect the DC connectors from the inverter under load, an electric arc may occur leading to electric shock and burns.

- Do not touch non-insulated cable ends.
- Do not touch the DC conductors.
- Do not touch any live components of the inverter.
- Have the inverter mounted, installed and commissioned only by qualified persons with the appropriate skills.
- If an error occurs, have it rectified by qualified persons only.
- Prior to performing any work on the inverter, disconnect it from all voltage sources as described in this document(see Section 9 "Disconnecting the Inverter from Voltage Sources").

WARNING

Risk of injury due to electric shock

- The inverter must be installed only by trained and authorized electricians.
- All electrical installations must be done in accordance with the National Wiring Rules standards and all locally applicable standards and directives.

NOTICE

Damage to the inverter due to electrostatic discharge

- Touching electronic components can cause damage to or destroy the inverter through electrostatic discharge.
- Ground yourself before touching any component.

5.2 System layout of units without integrated DC switch

Local standards or codes may require that PV systems are fitted with an external DC switch on the DC side. The DC switch must be able to safely disconnect the open-circuit voltage of the PV array plus a safety reserve of 20%.

Install a DC switch to each PV string to isolate the DC side of the inverter. We recommend the following electrical connection:

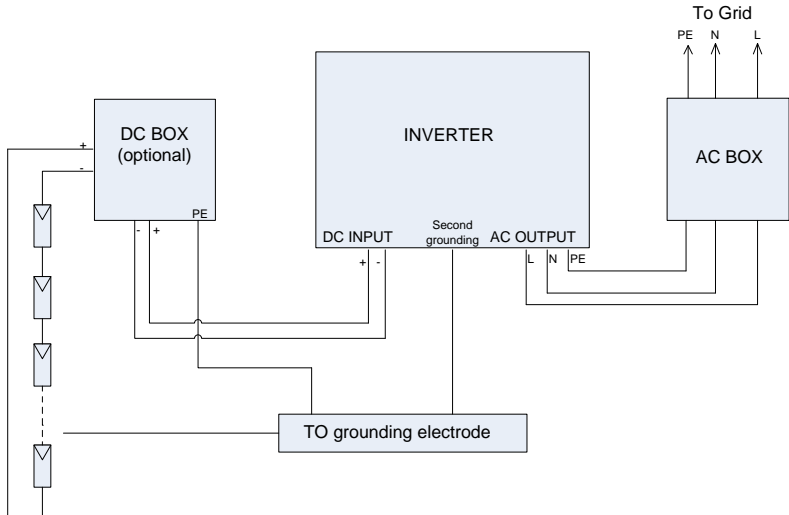

5.3 Overview of the connection area

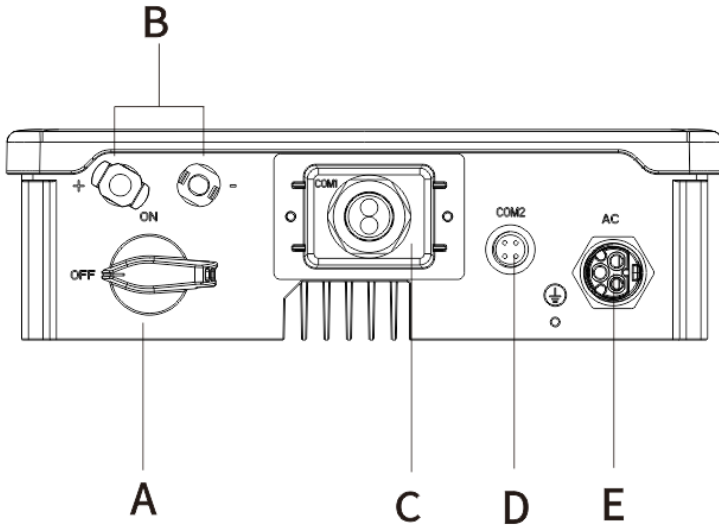

Objec	Description
A	DC SWITCH: switch on or off for PV-load.
B	DC input: plug-in connector to connect the strings.
C	COM: connect the monitoring device with communication cable.
D	GPRS or WiFi (optional): transmit and receive GPRS or Wi-Fi signal.
E	AC OUTPUT: plug-in connector, connect the grid.

5.4 AC connection

⚠ DANGER

Danger to life due to high voltages in the inverter

- Before establishing the electrical connection, ensure that the miniature circuit-breaker is switched off and cannot be reactivated.

5.4.1 Conditions for the AC connection

Cable Requirements

The grid connection is established using three conductors (L, N, and PE).

We recommend the following specifications for stranded copper wire.

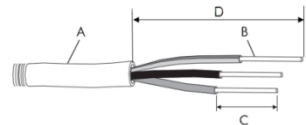

ASW3000-S/3680-S/4000-S/5000-S

Object	Description	Value
A	External diameter	8 to 16 mm
B	Conductor cross-section	2.5 to 6 mm ²
C	Stripping length of the insulated conductors	approx. 13 mm
D	Stripping length of the outer sheath of AC cable	approx. 53 mm

The PE conductor must be 2mm longer than the L and N conductors

Larger cross-sections should be used for longer cables.

Cable design

The conductor cross-section should be dimensioned to avoid power loss in cables exceeding 1% of rated output power.

The higher grid impedance of the AC cable makes it easier to disconnect from the grid due to excessive voltage at the feed-in point.

The maximum cable lengths depend on the conductor cross-section as follows:

Conductor cross-section	Maximum cable length			
	ASW1000S-S	ASW1500S-S	ASW2000S-S	ASW3000S-S
2.5 mm ²	46m	37 m	28 m	17 m
4 mm ²	74 m	59 m	44 m	28 m
6 mm ²	110 m	89 m	67 m	42 m

The required conductor cross-section depends on the inverter rating, ambient temperature, routing method, cable type, cable losses, applicable installation requirements of the country of installation, etc.

5.4.2 Grid connection

WARNING

Risk of injury due to electric shock and fire caused by high leakage current

- The inverter must be reliably grounded in order to protect property and personal safety.
- The PE wire should longer than 8mm during strip the outer sheath of AC cable.

NOTICE

Damage to the seal of the cover in sub-zero conditions

- If you open the cover in sub-zero condition, the sealing of the cover can be damaged. This can lead moisture entering the inverter.
- Do not open the inverter cover at ambient temperatures lower than - 5°C.
- If a layer of ice has formed on the seal of the cover in sub-zero conditions, remove it prior to opening the inverter(e.g. by melting the ice with warm air). Observe the applicable safety regulation.

Procedure:

1. Switch off the miniature circuit-breaker and secure it against being inadvertently switched back on.
2. Insert the conductor into a suitable ferrule acc. to DIN 46228-4 and crimp the contact.

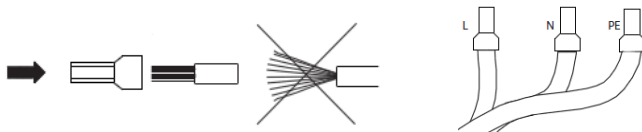

3. Unscrew the swivel nut from the threaded sleeve, then thread the swivel nut and threaded sleeve over the AC cable.

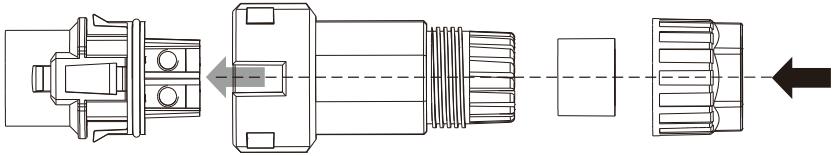

4. Insert the crimped conductors L, N and PE into the corresponding terminals and tighten the screw with a Torx screwdriver(TX 8, torque: 1.4Nm). Ensure that all conductors are securely in place in the screw terminals on the bush insert.

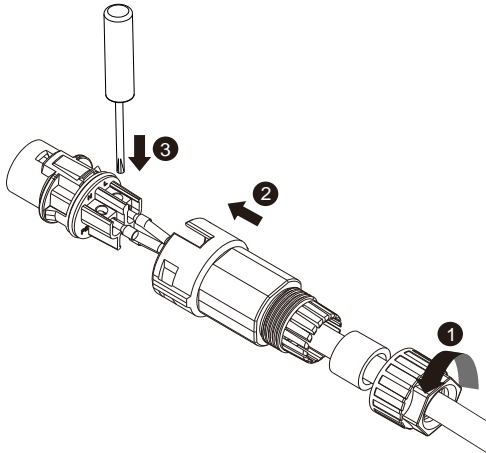

5. Assemble the locking cap, threaded sleeve and swivel nut together. When doing so, hold the bush insert firmly by the locking cap , This ensures that the threaded sleeve can be screwed firmly onto the bush insert. Then screw the threaded sleeve and swivel nut.
6. Plug the AC connector into the jack for the AC connection and screw tight. When doing so, align the AC connector so that the key on the inverter AC jack is inserted into the keyway on the AC connector bush insert.

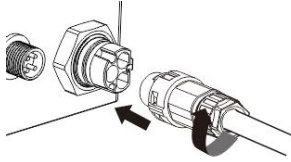

5.4.3 Second protective grounding connection

NOTICE

In case of operation on a Delta-IT Grid type, in order to ensure safety compliance in accordance with IEC 62109, the following step should be taken:

The second protective earth/ground conductor, with a diameter of at least 10 mm² and be made from copper, should be connected to the designated earth point on the inverter.

Procedure:

1. Insert the grounding conductor into the suitable terminal lug and crimp the contact.
2. Align the terminal lug with the grounding conductor on the screw.
3. Tighten it firmly into the housing (screwdriver type: PH2, torque: 1.6Nm).

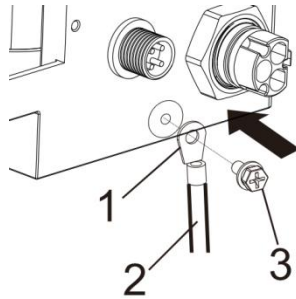

Information on grounding components:

Object	Description
1	M4 terminal lug
2	Grounding protective conductor
3	M4 screw

5.4.4 Residual current protection

The inverter is equipped with an all-pole sensitive residual current monitoring unit (RCMU) with an integrated differential current sensor which fulfills the requirements of DIN VDE 0100-712 (IEC60364-7-712:2002).

Therefore an external residual current device (RCD) is not required. If an external RCD needs to be installed because of local regulations, a RCD type A or type B can be installed as an additional safety measure.

The all-pole sensitive residual current monitoring unit (RCMU) detects alternating and direct differential currents. The integrated differential current sensor detects the current difference between the neutral conductor and the line conductor. If the current difference increases suddenly, the inverter disconnects from the grid. The function of the all-pole sensitive residual current monitoring unit (RCMU) has been tested in accordance with IEC 62109-2.



Rating of the external residual current device

- If an external residual current device (RCD) is required in a TT or TN-S system, install a residual current device which trips at a residual current of 100 mA or higher.
- For each connected inverter, a RCD with 100mA rated residual current has to be provided. The rated residual current of the RCD must be equal to at least the sum of the rated residual currents of the connected inverters. That means that, if, for example, two transformerless inverters are connected, the rated residual current of the RCD must be at least 200 mA.

5.4.5 Overvoltage category

The inverter can be deployed in grids of installation category III or lower, as defined under IEC 60664-1. This means that it can be permanently connected at the grid-connection point in a building. In installations involving long outdoor cable routing, additional overvoltage-reducing measures must be taken so that the overvoltage category is reduced from IV to III.

5.4.6 Grounding conductor monitoring

The inverter is equipped with a grounding conductor monitoring device. This grounding conductor monitoring device detects when there is no grounding conductor connected and disconnects the inverter from the utility grid if this is the case. Depending on the installation site and grid configuration, it may be advisable to deactivate the grounding conductor monitoring. This is necessary, for example, in an IT system if there is no neutral conductor present and you intend to install the inverter

between two line conductors. If you are uncertain about this, contact your grid operator or AISWEI-TECH.

5.4.7 Rating of miniature circuit-breaker



Danger to life due to fire

- You must protect each inverter with an individual miniature circuit-breaker in order that the inverter can be disconnected safely.

No load should be applied between the circuit-breaker and the inverter. Use dedicated circuit-breakers with load switch functionality for load switching. The selection of the circuit-breaker rating depends on the wiring design (wire cross-section area), cable type, wiring method, ambient temperature, inverter current rating etc. Derating of the circuit breaker rating may be necessary due to self-heating or if exposed to heat.

The maximum output currents of the inverters can be found in the following table.

Type	ASW1000S-S	ASW1500S-S	ASW2000S-S	ASW3000S-S
Max. output current	5A	7.5A	10A	13.6A
Recommended AC circuit breaker rating	16 A, type B	16 A, type B	16 A, type B	20A, type B

5.5 DC Connection

DANGER

Danger to life due to high voltages in the inverter

- Before connecting the PV array, ensure that the DC switch is switched off and that it cannot be reactivated.
- Do not disconnect the DC connectors under load.

5.5.1 Requirements for the DC Connection



Use of Y adapters for parallel connection of strings

The Y adapters must not be used to interrupt the DC circuit.

- Do not use the Y adapters in the immediate vicinity of the inverter. The adapters must not be visible or freely accessible.
- In order to interrupt the DC circuit, always disconnect the inverter as described in this document (see Section 9 "Disconnecting the Inverter from Voltage Sources").

Requirements for the PV modules of a string:

- PV modules of the connected strings must be of: the same type, identical alignment and identical tilt.
- The thresholds for the input voltage and the input current of the inverter must be adhered to (see Section 10.1 "Technical DC input data").
- On the coldest day based on statistical records, the open-circuit voltage of the PV array must never exceed the maximum input voltage of the inverter.
- The connection cables of the PV modules must be equipped with the connectors included in the scope of delivery.
- The positive connection cables of the PV modules must be equipped with the positive DC connectors. The negative

connection cables of the PV modules must be equipped with the negative DC connectors.

5.5.2 Assembling the DC connectors

DANGER

Danger to life due to high voltages on DC conductors

When exposed to sunlight, the PV array generates dangerous DC voltage which is present in the DC conductors. Touching the DC conductors can lead to lethal electric shocks.

- Cover the PV modules.
- Do not touch the DC conductors.

Assemble the DC connectors as described below. Be sure to observe the correct polarity. The DC connectors are marked with the symbols "+" and " - ".

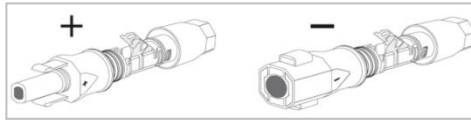

Cable requirements:

The cable must be of type PV1-F, UL-ZKLA or USE2 and comply with the following properties:

- ✧ External diameter: 5 mm to 8 mm
- ✧ Conductor cross-section: 2.5 mm² to 6 mm²
- ✧ Qty single wires: at least 7
- ✧ Nominal voltage: at least 600V

Proceed as follows to assemble each DC connector.

1. Strip 12 mm off the cable insulation.

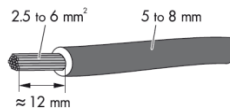

2. Route the stripped cable all the way into the DC connector.

Ensure that the stripped cable and the DC connector have the same polarity.

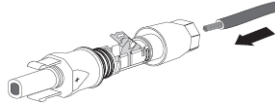

3. Press the clamping bracket down until it audibly snaps into place.

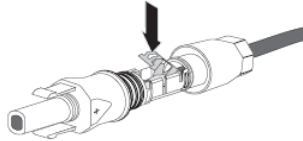

4. Ensure that the cable is correctly positioned:

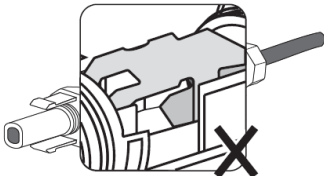
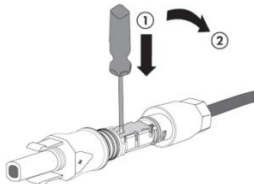
Result	Measure
<p>If the stranded wires are visible in the chamber of the clamping bracket, the cable is correctly positioned.</p> 	<ul style="list-style-type: none"> • Proceed to step 5.
<p>If the stranded wires are not visible in the chamber, the cable is not correctly positioned.</p> 	<ul style="list-style-type: none"> • Release the clamping bracket. To do so, insert a flat-blade screwdriver (blade width: 3.5 mm) into the clamping bracket and lever it open.  <ul style="list-style-type: none"> • Remove the cable and go back to step 2.

5. Push the swivel nut up to the thread and tighten (torque: 2 Nm).

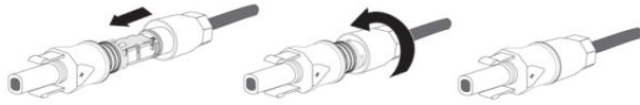

5.5.3 Disassembling the DC connectors

DANGER

Danger to life due to high voltages on DC conductors

When exposed to sunlight, the PV array generates dangerous DC voltage which is present in the DC conductors. Touching the DC conductors can lead to lethal electric shocks.

- Cover the PV modules.
- Do not touch the DC conductors.

1. Unscrew the swivel nut.

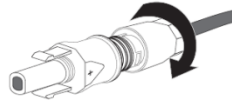

2. To release the DC connector, insert a flat-blade screwdriver (blade width: 3.5 mm) into the side catch mechanism and lever open.

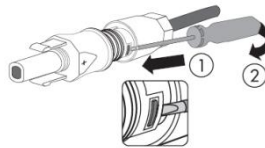

3. Carefully pull the DC connector apart.

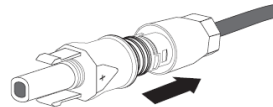

4. Release the clamping bracket. To do so, insert a flat-blade screwdriver (blade width: 3.5 mm) into the clamping bracket and lever it open.

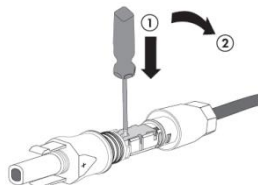

5. Remove the cable.

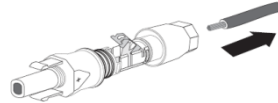

5.5.4 Connecting the PV array

NOTICE

The inverter can be destroyed by overvoltage

If the voltage of the strings exceeds the maximum DC input voltage of the inverter, it can be destroyed due to overvoltage. All warranty claims become void.

- Do not connect strings with an open-circuit voltage greater than the maximum DC input voltage of the inverter.
- Check the design of the PV system.

1. Ensure that the individual miniature circuit-breaker is switched off and ensure that it cannot be accidentally reconnected.
2. Ensure that the DC switch is switched off and ensure that it cannot be accidentally reconnected.
3. Ensure that there is no ground fault in the PV array.
4. Check whether the DC connector has the correct polarity.
If the DC connector is equipped with a DC cable having the wrong polarity, the DC connector must be reassembled. The DC cable must always have the same polarity as the DC connector.
5. Ensure that the open-circuit voltage of the PV array does not exceed the maximum DC input voltage of the inverter.
6. Connect the assembled DC connectors to the inverter until they audibly snap into place.
7. Ensure that all DC connectors are securely in place.

NOTICE

Damage to the inverter due to moisture and dust penetration

- Seal the unused DC inputs so that moisture and dust cannot penetrate the inverter.
- Make sure all DC connectors are securely sealed.

6 Communication

6.1 System monitoring via RS485/ Ethernet

This inverter is equipped with RJ45 interfaces for multipoint communication.

One AiCom/AiManager connects inverters via an RS485 bus.

The overall length of the network cable should not exceed 1,000 m. The monitoring system layout for inverters is as follows.

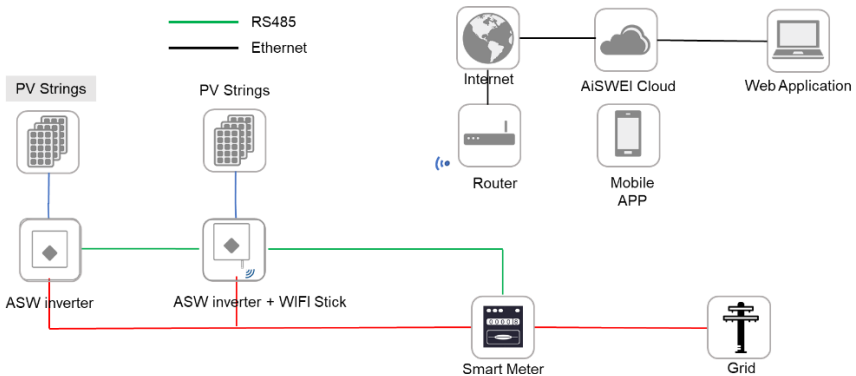

The AiCom/AiManager connects to the inverter via the RJ45 interface, and it connects to the router via Ethernet. User can monitor the inverter through the external AiCom/AiManager with Ethernet module (optional),



Possible reason of communication failure due to closed port

- The AiCom/AiManager uses port #1883 and #80 communicates with the AISWEIcloud. Both of these two ports must be opened, or else the AiCom/AiManager cannot connect to the AISWEIcloud and upload data.

The inverter is connected to the network by simply connecting the network cable from the router to the Ethernet port on the AiCom/AiManager. For connecting the network cable, please refer to the relative instruction at section 6.1.



Possible reason of communication failure due to DHCP

- The router needs to support DHCP services if the AiCom/AiManager use the DHCP function.

The inverter obtains an IP address from the router via DHCP automatically and shows it on the display. The time it takes to connect to the network depends on the network communication conditions.

We offer a remote monitoring platform called “AiSWEI Cloud”. You can install the “AiSWEI Cloud” application on a smart phone using Android or an iOS operating systems.

You can also visit the website (<http://www.aisweicloud.com>) for system information. And download the user manual for the AISWEI Cloud Web or AISWEI Cloud APP.

The pin assignment of the RJ45 socket is as follows:

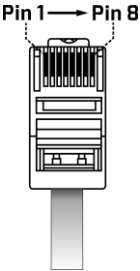
Pin1----- TX_RS485A	
Pin2-----TX_RS485B	
Pin3-----NC	
Pin4-----GND	
Pin5-----GND	
Pin6-----NC	
Pin7-----+7V	
Pin8-----+7V	

The network cable meeting the EIA/TIA 568A or 568B standard must be UV resistant if it is to be used outdoors.

Cable requirement :

- Shielding wire
- CAT-5E or higher
- UV-resistant for outdoor use
- RS485 cable maximum length 1000m

Connect the network cable:

NOTICE

The inverter can be destroyed by wrong communication wiring







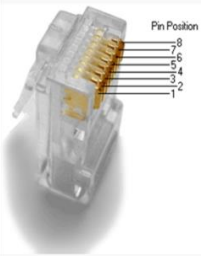

- Internal components of the inverter can be irreparably damaged due to incorrect wiring between the power wire and signal wire. All the warranty claim will be invalid.
- Please check the wiring of the RJ45 connector before crimping the contact.

NOTICE

Damage to the inverter due to moisture and dust penetration

- If the cable gland are not mounted properly, the inverter can be destroyed due to moisture and dust penetration. All the warranty claim will be invalid.
- Make sure the cable gland has been tightened firmly.

1. Take out the cable fixing accessory from the package.
2. Unscrew the swivel nut of the M25 cable gland, remove the filler-plug from the cable gland and keep it well. If there is only one network cable, please keep a filler-plug in the remaining hole of the sealing ring against water ingress.
3. Current pin assignment for the network cable as per EIA/TIA 568 standard:

Pin	T568A Color	Pins on plug face (socket is reversed)
1	 white/green stripe	
2	 green solid	
3	 white/orange stripe	
4	 blue solid	
5	 white/blue stripe	
6	 orange solid	
7	 white/brown stripe	
8	 brown solid	

4. Route the cable into the inverter through the M25 cable gland, then connect it.

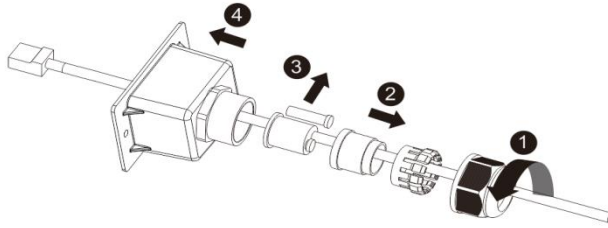

5. Connect the inverter to AiCom/AiManager or another communication device via the above-mentioned network cable.
6. Secure the cover (torque: 2.5 Nm) using a screwdriver (T25).
7. Tighten the swivel nut firmly (torque: 3.0-3.5Nm). Make sure the cable gland is mounted properly. The cable gland must be adequately locked to prevent any movement of the cable.

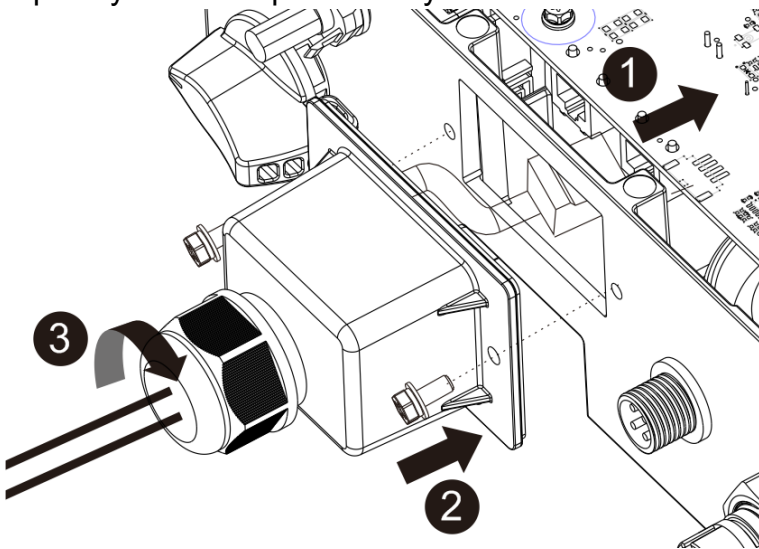

Disassemble the network cable in reverse order.

6.2 System monitoring via WLAN

User can monitor the inverter through the external WIFI stick with WLAN module (optional). The connection diagram between the inverter and internet with a WLAN connection is shown as follows.

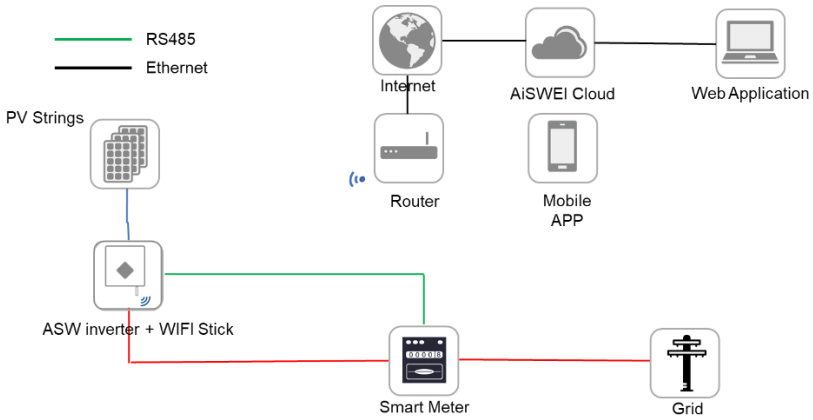

Mounting the WiFi or GPRS modular:

Take out the WiFi/GPRS modular included in the scope of delivery. Attach the WiFi modular to the connection port in place and tighten it into the port by hand with the nut in the modular. Make sure the modular is securely connected and the label on the modular can be seen.

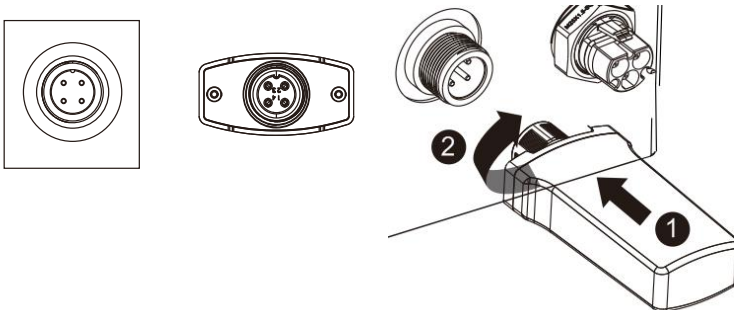

We offer a remote monitoring platform called “AiSWEI Cloud”. You can install the “AiSWEI Cloud” application on a smart phone using Android or an iOS operating systems. You can also visit the website (<http://www.aisweicloud.com>) for system information. And download the user manual for the AISWEI Cloud Web or AISWEI Cloud APP.

6.3 Inverter demand response modes (DRED)



DRMS application description

- Only applicable to AS/NZS4777.2:2015.
- DRM0, DRM5, DRM6, DRM7, DRM8 are available.

The inverter shall detect and initiate a response to all supported demand response commands , demand response modes are described as follows:

Mode	Requirement
DRM 0	Operate the disconnection device
DRM 1	Do not consume power
DRM 2	Do not consume at more than 50% of rated power
DRM 3	Do not consume at more than 75% of rated power AND Source reactive power if capable
DRM 4	Increase power consumption (subject to constraints from other active DRMs)
DRM 5	Do not generate power
DRM 6	Do not generate at more than 50% of rated power
DRM 7	Do not generate at more than 75% of rated power AND Sink reactive power if capable
DRM 8	Increase power generation (subject to constraints from other active DRMs)

The RJ45 socket pin assignments for demand response modes as follows:

Pin1----- DRM 1/5	<p>PIN 1 --> 8</p> <p>RJ45 SOCKET</p>
Pin2----- DRM 2/6	
Pin3----- DRM 3/7	
Pin4----- DRM 4/8	
Pin5----- RefGen	
Pin6----- Com/DRM0	
Pin7-----N/A	
Pin8----- N/A	

6.4 Active power control with Smart meter & AiCom/AiManager

The inverter can control active power output via connecting smart meter and external AiCom/AiManager in AISWEI's inverter, following is the system connection mode.

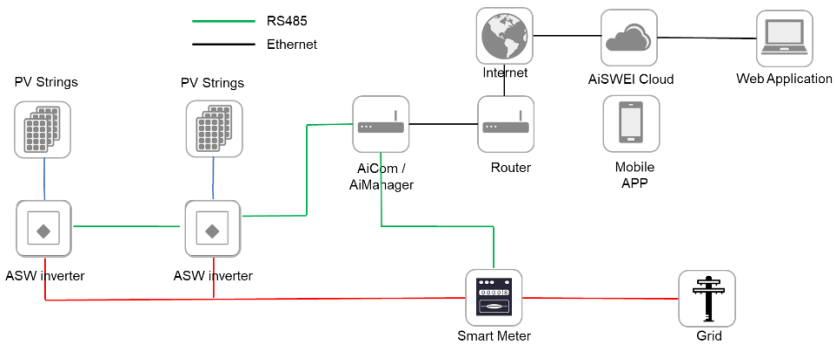

smart meter as above SDM120-Modbus connecting method and setting baud rate method for modbus please refer to its user manual.

NOTICE

Possible reason of communication failure due to incorrect connection

- AiCOM/AiMANAGER only supports single inverter to do active power control
- The overall length of the cable from AiCOM/AiMANAGER to smart meter should not exceed 1,000 m

6.5 Communication with third-party devices

Solplanet inverters can communicate with Solarlog or Meteocontrol, in other words, you can use Solarlog or Meteocontrol to monitor Solplanet inverters. For more information, please refer to their user manual.

6.6 Earth Fault Alarm

This inverter complies with IEC 62109-2 clause 13.9 for earth fault alarm monitoring. If an Earth Fault Alarm occurs, the red color LED indicator will light up and the buzzer of the inverter will keep ringing. At the same time, the error code 38 will be sent to the AISWEI Cloud. (This function is only available in Australia and New Zealand).

7 Commissioning

NOTICE

Risk of injury due to incorrect installation

- We strongly recommend carrying out preliminary checks before commissioning to avoid possible damage to the device caused by faulty installation.

7.1 Electrical checks

Carry out the main electrical tests as follows:

- ① Check the PE connection with a multimeter: make sure that the inverter's exposed metal surface has a ground connection.

DANGER

Danger to life due to the presence of DC voltage

- Only touch the insulation of the PV array cables.
- Do not touch parts of the sub-structure and frame of PV array.
- Wear personal protective equipment such as insulating gloves.

- ② Check the DC voltage values: check that the DC voltage of the strings does not exceed the permitted limits. Refer to the Section 2.1 "Intended use" about designing the PV system for the maximum allowed DC voltage.
- ③ Check the polarity of the DC voltage: make sure the DC voltage has the correct polarity.
- ④ Check the PV array's insulation to ground with a multimeter: make sure that the insulation resistance to ground is greater than 1 MOhm.

DANGER

Danger to life due to the presence of AC voltage

- Only touch the insulation of the AC cables.
- Wear personal protective equipment such as insulating gloves.

- ⑤ Check the grid voltage: check that the grid voltage at the point of connection of the inverter complies with the permitted value.

7.2 Mechanical checks

Carry out the main mechanical checks to ensure the inverter is waterproof:

- ① Make sure the inverter has been correctly mounted with wall bracket.
- ② Make sure the cover has been correctly mounted.
- ③ Make sure the communication cable and AC connector have been correctly wired and tightened.

7.3 Safety code check

Choose suitable safety code according to the location of installation. please visit website (<http://www.aisweicloud.com>) and download the AISWEI Cloud APP manual for detailed information, you can find the Safety Code Setting Guide in an event where an installer needs to set the country code manually.



Information for safety code

- The Solplanet's inverters comply with local safety code when leaving the factory.

7.4 Start-Up

After finishing the electrical and mechanical checks, switch on the miniature circuit-breaker and DC-switch in turn. Once the DC input voltage is sufficiently high and the grid-connection conditions are met, the inverter will start operation automatically. Usually, there are three states during operation:

Waiting: When the initial voltage of the strings is greater than the minimum DC input voltage but lower than the start-up DC input voltage, the inverter is waiting for sufficient DC input voltage and cannot feed power into the grid.

Checking: When the initial voltage of the strings exceeds the start-up DC input voltage, the inverter will check feeding conditions at once. If there is anything wrong during checking, the inverter will switch to the “Fault” mode.

Normal: After checking, the inverter will switch to “Normal” state and feed power into the grid.

During periods of low radiation, the inverter may continuously start up and shut down. This is due to insufficient power generated by the PV array.

If this fault occurs often, please call service.



Quick Troubleshooting

If the inverter is in "Fault" mode, refer to Section 11 "Troubleshooting".

8 Display

The information provided here covers the LED indicators.

8.1 Overview of the panel

The inverter is equipped with three LEDs indicators.

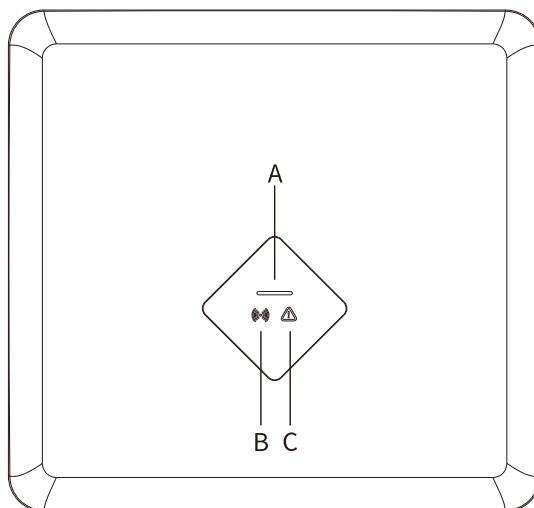

Object	Description
A	Normal (Green LED)
B	Communication (Blue LED)
C	Fault (Red LED)

8.1.1 LEDs

The inverter is equipped with three LED indicators “green”, “blue” and “red” which provide information about the various operating states.

Green LED:

The green LED is lit when the inverter is operating normally. The green LED is off The inverter is not feeding into the utility grid. The inverter is equipped with a dynamic power display via the green LED. Depending on the power, the green LED pulses fast or slow.If the power is less than 45% of power,the green LED pulses slow.If the power is greater than 45% of power and less than 90% of power ,the green LED pulses fast.The green LED is glowing when the inverter is in Feed-in operation with a power of at least 90% of power.

Blue LED:

The blue LED flashes during communication with other devices e.g. AiCom/AiManager, Solarlog etc. Also, the blue LED flashes during firmware update through RS485.

Red LED:

The red LED is lit when the inverter has stopped feeding power into the grid due to a fault. The corresponding error code will be shown on the display.

9 Disconnecting the Inverter from Voltage Sources

Prior to performing any work on the inverter, disconnect it from all voltage sources as described in this section. Always adhere strictly to the prescribed sequence.

NOTICE

Destruction of the measuring device due to overvoltage

- Only use measuring devices with a DC input voltage range of 580 V or higher.

Procedure:

1. Disconnect the miniature circuit- breaker and secure against reconnection.
2. Disconnect the DC switch and secure against reconnection.
3. Use a current clamp meter to ensure that no current is present in the DC cables.
4. Release and remove all DC connectors. Insert a flat-blade screwdriver or an angled screwdriver (blade width: 3.5 mm) into one of the slide slots and pull the DC connectors out downwards. Do not pull on the cable.

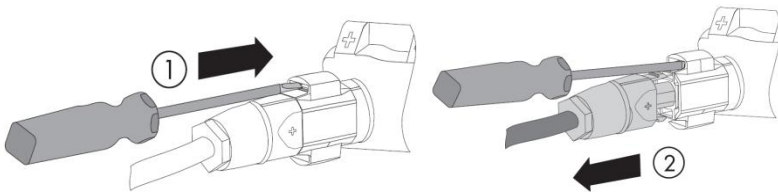

5. Ensure that no voltage is present at the DC inputs of the inverter.
6. Remove the AC connector from the jack. Use a suitable measuring device to check that no voltage is present at the AC connector between L and N and L and PE.

NOTICE

Damage to the inverter due to electrostatic discharge

- Touching electronic components can cause damage to or destroy the inverter through electrostatic discharge.
- Ground yourself before touching any component.

10 Technical Data

10.1 DC input data

Type	ASW1000S -S	ASW1500S -S	ASW2000S- S	ASW3000S -S
Max. PV array power(STC)	1500Wp	2250Wp	3000Wp	4500Wp
Max. input voltage	580V			
MPP voltage range	80V-550V			
Rated input voltage	360V			
Initial feeding-in voltage	100V			
Min. feed-in power	20W			
Max. input current per MPP input	12A			
Isc PV(absolute maximum)	18A			
Number of independent MPP inputs	1			
Strings per MPP input	1			
Max. inverter backfeed current to the array	0A			

10.2 AC output data

Type	ASW1000S-S	ASW1500S-S	ASW2000S-S	ASW3000S-S
Rated active power	1000W	1500W	2000W	3000W
Max. apparent AC power	1000VA	1500VA	2000VA	3000VA
Nominal AC voltage/ range	220V,230V,240V/180V-280V			
AC power frequency/ range	50, 60/±5Hz			
Rated power frequency/rated grid voltage	50Hz/230V			
Max. output current	5A	7.5A	10A	13.6A
Max. output fault current	14A	14A	14A	21A
Max. output overcurrent protection	16A	16A	16A	25A
Inrush current	<20% of nominal AC current for a maximum of 10ms			
Power factor (@rated power)	1			
Adjustable displacement power factor	0.95 inductive ... 0.95 capacitive (only for VDE-AR-N 4105)			
	0.8 inductive.... 0.8 capacitive (for others)			
Feed-in phase / connection phase	1/1			

Harmonic distortion (THD) at rated output	<3%
---	-----

10.3 General data

General data	ASW1000S-S/ 1500S-S / 2000S-S / 3000S-S
communication: WIFI/Meter/RS485/GPRS	○/●/●/○
Display	LED
Earth Fault Alarm	cloud based, audible and visible(AU)
Zero power output	Via connecting Smart meter
Dimensions (W x H x D mm)	320x264x94
Weight	6.5Kg
Cooling concept	convection
Noise emission (typical)	< 15 dB(A)@1m
Installation	indoor & outdoor
Mounting information	wall mounting bracket
DC connection technology	SUNCLIX
AC connection technology	Plug-in Connector
Operating temperature range	-25°C ...+60°C / -13°F ...+140°F
Relative humidity (non-condensing)	0% ... 100%
Max. operating altitude	4000m(>3000m derating)
Degree of protection (according to IEC 60529)	IP65
Climatic category (according to IEC 60721-3-4)	4K4H
Topology	BOOST+H6.5
Self-consumption (night)	<1W
Radio technology	WLAN 802.11 b / g / n
Radio spectrum	2.4 GHz
Standby power	<5W

10.4 Safety regulations

Protective devices	ASW1000S-S / 1500S-S / 2000S-S / 3000S-S
DC isolator	●
PV iso / Grid monitoring	● / ●
DC reverse polarity protection / AC short-circuit current capability	● / ●
Residual current monitoring(GFCI) function	●
Earth Fault Alarm	cloud based, audible and visible(AU)
Protection class (according to IEC 62103) / overvoltage category (according to IEC 60664-1)	I / II(DC), III(AC)
Internal overvoltage protection	Integrated
DC feed-in monitoring	Integrated
Islanding protection	Integrated
EMC immunity	EN61000-6-1, EN61000-6-2
EMC emission	EN61000-6-3, EN61000-6-4
Utility interference	EN61000-3-2, EN61000-3-3

●—Standard ○—Optional —N/A



If you use the standard VDE-AR-N 4105, please refer to the information below !

- If a central NS protection device is used, then the value of the voltage protection $U > 1.1U_n$ in the integrated NS protection can be changed with a password.
- The displacement factor $\cos(\phi)$ value is not necessary to be adjustable if the power generation system $\Sigma S_{Amax} \leq 3.68\text{KVA}$ and was set to 1 as default in the embedded inverter software. However, if the power generation system is such that $3.68\text{KVA} < \Sigma S_{Amax} \leq 13.8\text{KVA}$, the standard $\cos(\phi)$ characteristic curve defined in VDE-AR-N 4105 shall be applied through the AiCom/AiManager .

10.5 Efficiency

The operating efficiency is shown for the three input voltages ($V_{mpphigh}$, $V_{dc,r}$ and V_{mpplow}) graphically. In all cases the efficiency refers to the standardized power output ($P_{ac}/P_{ac,r}$). (according to EN 50524 (VDE 0126-13): 2008-10, cl. 4.5.3).

Notes: Values are based on rated grid voltage, $\cos(\phi) = 1$ and an ambient temperature of 25 °C.

Efficiency curve ASW1000S-S

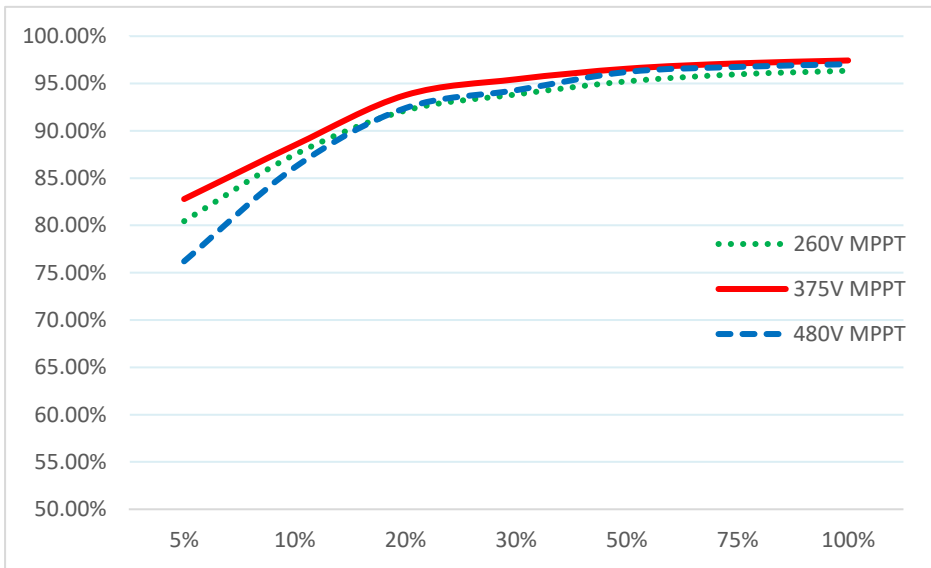

Efficiency	
Max. efficiency / European weighted efficiency	97.43% / 95.36%
MPPT efficiency	99.9%

Efficiency curve ASW1500S-S

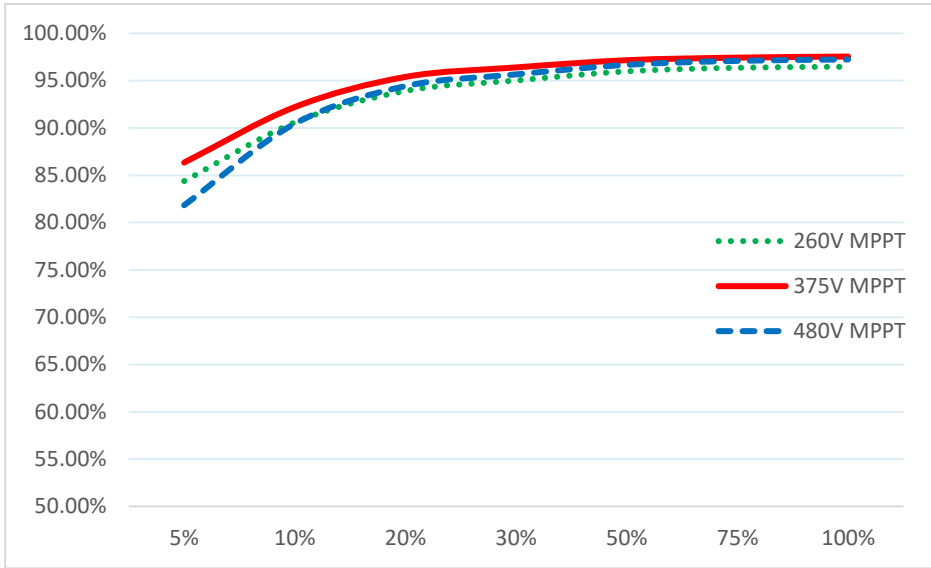

Efficiency	
Max. efficiency / European weighted efficiency	97.55% / 96.31%
MPPT efficiency	99.9%

Efficiency curve ASW2000S-S

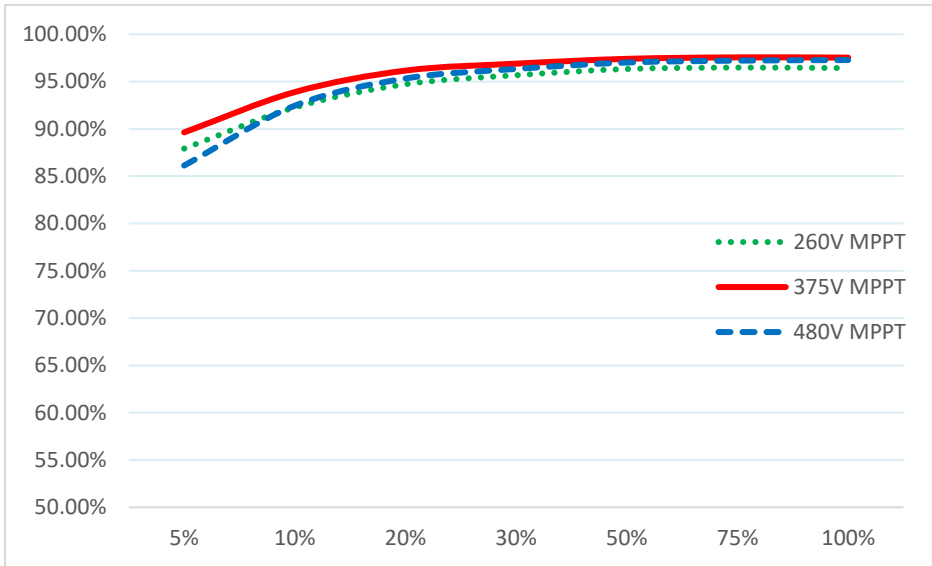

Efficiency	
Max. efficiency / European weighted efficiency	97.55% / 96.76%
MPPT efficiency	99.9%

Efficiency curve ASW3000S-S

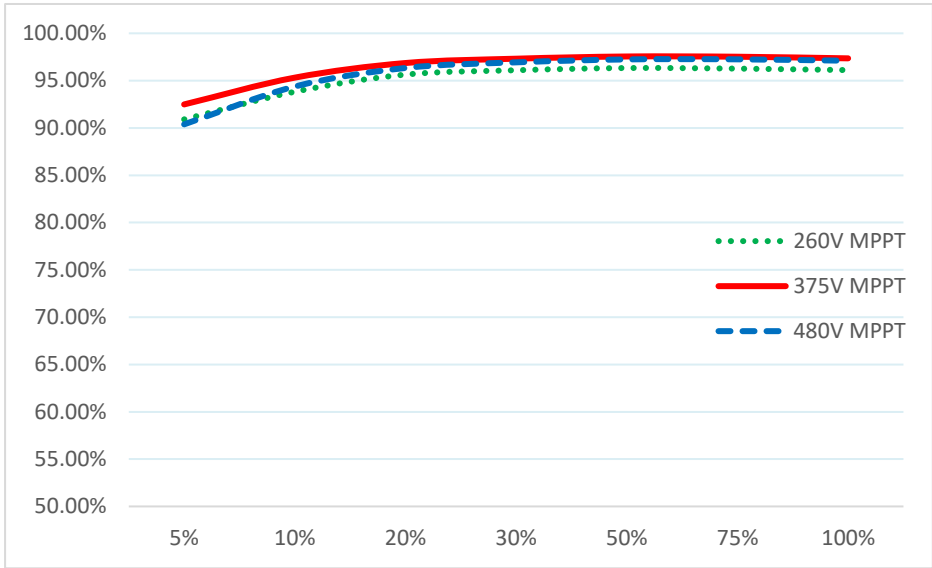

Efficiency	
Max. efficiency / European weighted efficiency	97.55% / 97.11%
MPPT efficiency	99.9%

10.6 Power reduction

In order to ensure inverter operation under safe conditions, the device may automatically decrease power output.

Power reduction depends on many operating parameters including ambient temperature and input voltage, grid voltage, grid frequency and power available from the PV modules. This device can decrease power output during certain periods of the day according to these parameters.

Notes: Values are based on rated grid voltage and $\cos(\phi) = 1$.

10.6.1 Power reduction with increased ambient temperature (ASW1000S-S)

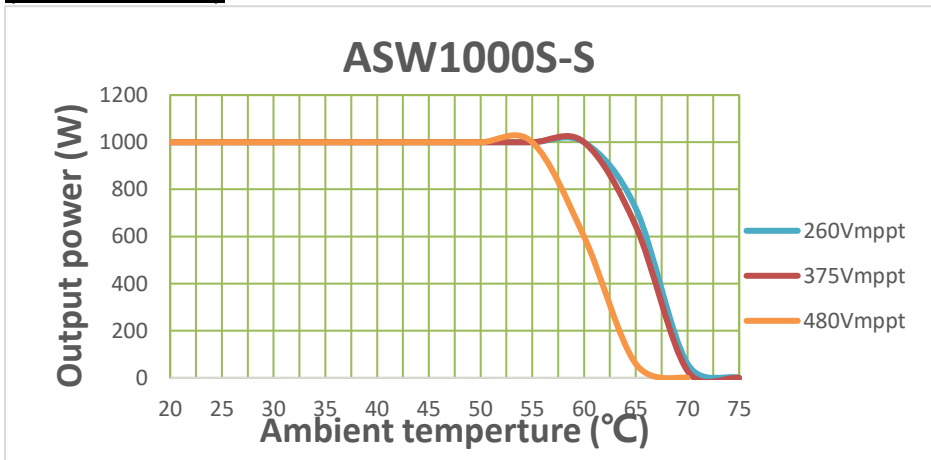

10.6.2 Power reduction with increased ambient temperature (ASW1500S-S)

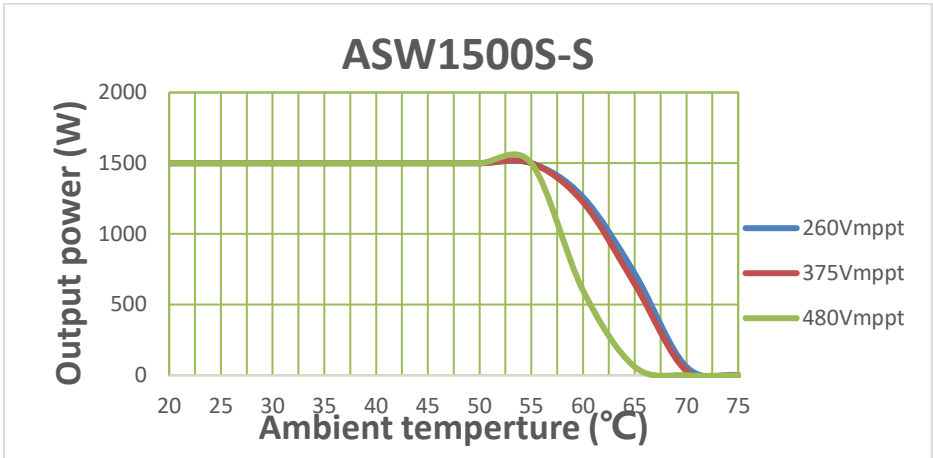

10.6.3 Power reduction with increased ambient temperature (ASW2000S-S)

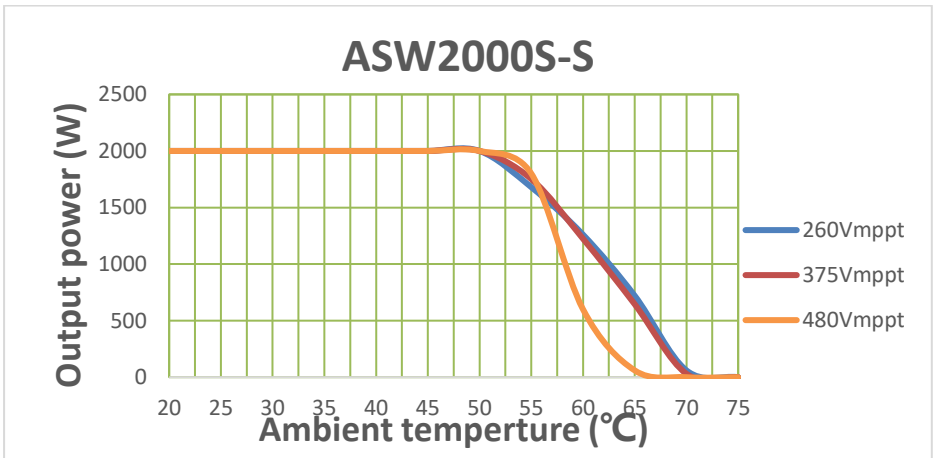

10.6.4 Power reduction with increased ambient temperature (ASW3000S-S)

ASW3000S-S

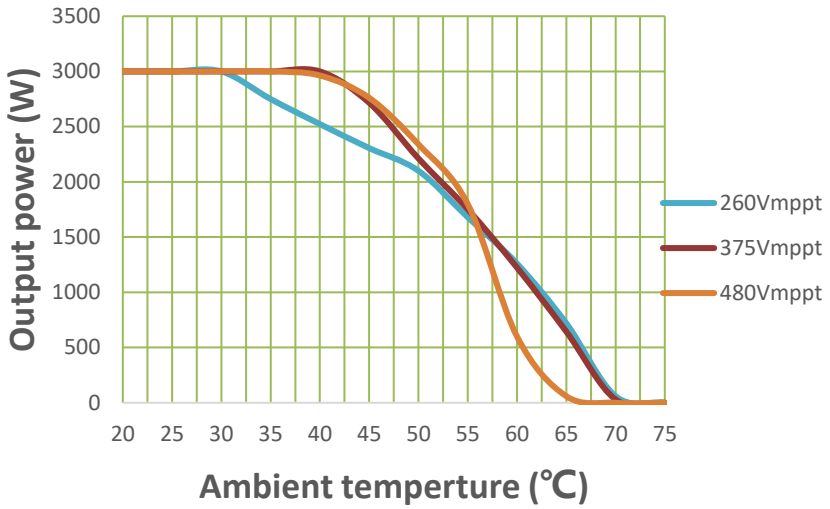

The power reduction curve is tested at normal air pressure! Different air pressure condition will cause different test result

10.7 Tools and torque

Tools and torque required for installation and electrical connections.

Tools, model		Object	Torque
Torque screwdriver, T25		Screws for the cover	2.5Nm
Torque screwdriver, T20		Screw for second protective grounding connection	1.6Nm
		Screws for connecting the inverter and wall bracket	
Flat-head screwdriver, blade with 3.5mm		Sunclix DC connector	/
Flat-head screwdriver, blade 0.4x2.5		Smart meter connector	/
/		Stick	Hand-tight
Socket wrench	Open end of 33	Swivel nut of M25 cable gland	Hand-tight
	Open end of 15	Swivel nut of sunclix connector	2.0Nm
Wire stripper		Peel cable jackets	/
Crimping tools		Crimp power cables	/
Hammer drill, drill bit of Ø10		Drill holes on the wall	/
Rubber mallet		Hammer wall plugs into holes	/
Cable cutter		Cut power cables	/
Multimeter		Check electrical connection	/
Marker		Mark the positions of drill holes	/
ESD glove		Wear ESD glove when opening the inverter	/
Safety goggle		Wear safety goggle during drilling holes.	/
Anti-dust respirator		Wear anti-dust respirator during drilling holes.	/

11 Troubleshooting

When the PV system does not operate normally, we recommend the following solutions for quick troubleshooting. If an error occurs, the red LED will light up. There will have "Event Messages" display in the monitor tools. The corresponding corrective measures are as follows:

Object	Error code	Corrective measures
Presumable Fault	6	<ul style="list-style-type: none"> • Check the open-circuit voltages of the strings and make sure it is below the maximum DC input voltage of the inverter. • If the input voltage is within the permitted range and the fault still occurs, it might be that the internal circuit has broken. Contact the service.
	33	<ul style="list-style-type: none"> • Check the grid frequency and observe how often major fluctuations occur. <p>If this fault is caused by frequent fluctuations, try to modify the operating parameters after informing the grid operator first.</p>
	34	<ul style="list-style-type: none"> • Check the grid voltage and grid connection on inverter. • Check the grid voltage at the point of connection of inverter. <p>If the grid voltage is outside the permissible range due to local grid conditions, try to modify the values of the monitored operational limits after informing the electric utility company first.</p> <p>If the grid voltage lies within the permitted range and this fault still occurs, please call service.</p>
	35	<ul style="list-style-type: none"> • Check the fuse and the triggering of the circuit breaker in the distribution box. • Check the grid voltage, grid usability.

Presumable Fault		<ul style="list-style-type: none"> • Check the AC cable, grid connection on the inverter. <p>If this fault is still being shown, contact the service.</p>
	36	<ul style="list-style-type: none"> • Make sure the grounding connection of the inverter is reliable. • Make a visual inspection of all PV cables and modules. <p>If this fault is still shown, contact the service.</p>
	37	<ul style="list-style-type: none"> • Check the open-circuit voltages of the strings and make sure it is below the maximum DC input voltage of the inverter. <p>If the input voltage lies within the permitted range and the fault still occurs, please call service.</p>
	38	<ul style="list-style-type: none"> • Check the PV array's insulation to ground and make sure that the insulation resistance to ground is greater than 1 MOhm. Otherwise, make a visual inspection of all PV cables and modules. • Make sure the grounding connection of the inverter is reliable. <p>If this fault occurs often, contact the service.</p>
	40	<ul style="list-style-type: none"> • Check whether the airflow to the heat sink is obstructed. • Check whether the ambient temperature around the inverter is too high.
	41, 42 43, 44 45 47	<ul style="list-style-type: none"> • Disconnect the inverter from the grid and the PV array and reconnect after 3 minutes. <p>If this fault is still being shown, contact the service.</p>
	61 62	Check the DRED device communication or operation
	65	<ul style="list-style-type: none"> • Check if the ground line is connected with the

		inverter ; • Make sure the grounding connection of the inverter is connected and reliable. If this fault occurs often, contact the service.
Permanent Fault	1, 2,3, 4,5,6, 8,9	• Disconnect the inverter from the utility grid and the PV array and reconnect it after LCD and LED turn off. If this fault is still being displayed, contact the service.

Contact the service if you meet other problems not in the table.

12 Maintenance

Normally, the inverter needs no maintenance or calibration. Regularly inspect the inverter and the cables for visible damage. Disconnect the inverter from all power sources before cleaning. Clean the enclosure with a soft cloth. Ensure the heat sink at the rear of the inverter is not covered.

12.1 Cleaning the contacts of the DC switch

Clean the contacts of the DC switch annually. Perform cleaning by cycling the switch to on and off positions 5 times. The DC switch is located at the lower left of the enclosure.

12.2 Cleaning the heat sink

CAUTION

Risk of injury due to hot heat sink

- The heat sink may exceed 70 °C during operation. Do not touch the heat sink during operation.
- Wait approx. 30 minutes before cleaning until the heat sink has cooled down.
- Ground yourself before touching any component.

Clean the heat sink with compressed air or a soft brush. Do not use aggressive chemicals, cleaning solvents or strong detergents.

For proper function and long service life, ensure free air circulation around the heat sink.

13 Recycling and disposal

Dispose of the packaging and replaced parts according to the rules applicable in the country where the device is installed.



Do not dispose the Solplanet inverter with normal domestic waste.



INFORMATION

- Do not dispose of the product together with the household waste but in accordance with the disposal regulations for electronic waste applicable at the installation site.

14 EU Declaration of Conformity

within the scope of the EU directives

- Electromagnetic compatibility 2014/30/EU (L 96/79-106, March 29, 2014) (EMC).
- Low Voltage Directive 2014/35/EU.(L 96/357-374, March 29, 2014)(LVD).
- Radio Equipment Directive 2014/53/EU (L 153/62-106. May 22. 2014) (RED)

AISWEI New Energy Technology (Jiangsu) Co., Ltd. confirms herewith that the inverters described in this document are in compliance with the fundamental requirements and other relevant provisions of the abovementioned directives. The entire EU Declaration of Conformity can be found at www.aiswei-tech.com.

15 Warranty

The factory warranty card is enclosed with the package, please keep well the factory warranty card. Warranty terms and conditions can be downloaded at <http://www.aiswei-tech.com> if required. When the customer needs warranty service during the warranty period, the customer must provide a copy of the invoice, factory warranty card, and ensure the electrical label of the inverter is legible. If these conditions are not met, AISWEI has the right to refuse to provide with the relevant warranty service.

16 Contact

If you have any technical problems concerning our products, please contact AISWEI service. We require the following information in order to provide you with the necessary assistance:

- Inverter device type
- Inverter serial number

- Type and number of connected PV modules
- Error code
- Mounting location
- Installation date
- Warranty card

Service Contact

Our regional services contact information can be found at :

<https://en.aiswei-tech.com/intro/Customer-Interaction-Center-3.html>

AISWEI New Energy Technology (Jiangsu) Co., Ltd.

Tel.: +86 512 6937 0998

Fax: +86 512 6937 3159

Web: www.AISWEI-tech.com

Factory add.: No.588 Gangxing Road, Yangzhong Jiangsu,
China

Headquarters add.: Building 9, No.198 Xiangyang Road, Suzhou
215011, China

